



ELECRAFT® PX3

HIGH-PERFORMANCE PANADAPTER

OWNER'S MANUAL

Revision A4, February 2, 2015

Copyright © 2015, Elecraft, Inc.

All Rights Reserved

For Owners of the Elecraft K3 Transceiver and P3 Panoramic Display:

The PX3 has nearly all of the same features as the P3*, including the same high-resolution color display, 2 to 200 kHz SPAN, fast sweep rates, and eight programmable “hot keys” to do quick setup. The primary difference between the two is in the interface to the transceiver. The P3 digitally down-converts the K3’s 8.215-MHz I.F. signal, while the PX3 uses quadrature baseband demodulation (I/Q) to convert signals from the KX3’s RX I/Q output jack. The PX3’s method requires less interface and demodulation circuitry, resulting in a significantly lower-cost unit with lower power consumption (consistent with portable use). For details on how baseband I/Q demodulation impacts performance, see *PX3 Compared to the P3 and PC-Based Panadapters* on page 34

* “Fixed tune” mode is not yet available in the PX3. If this feature is added at a future date, it may have somewhat different performance than in the P3, in terms of displayed bandwidth and allowed offset from the currently-tuned frequency.

Contents

⚠ If you purchased the PX3 Kit, go directly to page 37 to assemble your PX3

Key to Symbols and Text Styles.....	4	Command Tester.....	22
In the Box	5	Capturing Screen Displays	22
Serial Data Cable.....	5	Configuring the Power Switch.....	22
PX3-KX3 Interface Cable (PX3CBL).....	5	Operation with Transverters	23
DC Power Cable (E850524).....	5	Tuning Direction.....	23
Quick-Start Guide.....	6	Amplitude Calibration for Transverters.....	23
Introduction.....	10	Firmware Upgrades.....	24
PX3 Features	10	Checking your Firmware Revision	24
Easy Set-Up.....	10	Forcing a Firmware Download.....	24
Display	10	Updating KX3 Firmware	24
Ergonomic Design.....	10	Opposite Sideband Nulling.....	25
Field Upgradable.....	10	Getting Ready	25
Front Panel.....	11	Setting up the PX3 and KX3 to use the PX3	
Control Groups.....	11	Internal Calibration Signal.....	29
Display	12	Menu Functions	30
Primary Controls	12	PX3 Menu.....	30
Menu	13	Troubleshooting	32
Programmable Function Keys.....	13	Power On/Off Issues.....	32
Side Panel Connectors	14	Display Issues	32
Basic Operation	15	Parameter Initialization.....	33
Using Tap/Hold Switches	15	PX3 Compared to the P3 and PC-Based	
Initial Power-Up.....	15	Panadapters	34
Configuring the Display	15	Theory of Operation.....	35
Using the Menu	15	RS-232 Serial Interface Cable	36
Programmable Functions	16	Kit Assembly Instructions	37
Adjusting the Amplitude	16	Preventing Electrostatic Discharge Damage.....	37
Adjusting the Frequencies Displayed.....	16	Tools Required	37
Using Markers.....	16	Parts List.....	38
Waterfall Markers	17	PX3 Front Panel Assembly Bag E850621	38
Using Cursors.....	17	Individually Wrapped Components.....	38
Noise Blanker.....	18	PX3 Misc Bag - E850615.....	39
Decoding Text.....	18	PX3 Hardware Envelope – E850614.....	40
How to Set Up and Interpret the PX3 Display		Assembly Procedure	41
.....	19	Overview of the Kit	41
Spectrum Display	19	Servicing the PX3	53
Waterfall Display	20	Accessing the PC Boards.....	53
Averaging and Peak Hold	20	Cleaning the LCD Bezel.....	53
Span.....	20	Replacing the LCD	54
Typical Spectra.....	20	Specifications	55
Advanced Operating Features.....	22	Customer Service and Support.....	56
Remote-Control Commands.....	22	Technical Assistance	56
PX3 Utility Program	22	Repair / Alignment Service	56
Configuration Save and Restore.....	22		

⚠ Elecraft manuals with color images may be downloaded from www.elecraft.com.

Key to Symbols and Text Styles

 Identifies important information.

 Operating or kit assembly tip.

-100 Characters displayed on the LCD screen

DISP *Tap* switch function (labeled *above* a switch)

AVERAGE *Hold* switch function (labeled *below* a switch; hold for 1/2 sec. to activate)

MENU:Font Typical menu entry

In the Box

In addition to the PX3 display itself, check the shipping box for the following contents.

Serial Data Cable

Connects the PX3 to a serial port on your personal computer to upload updated firmware and provide other functions. If needed a serial cable with an RS232 interface is available (order the KXSER). These cables are identical to and interchangeable with the serial interface cable used with the KX3 transceiver. If desired, you can make your own RS232 serial interface cable. See page 36 for the schematic diagram.



PX3-KX3 Interface Cable (PX3CBL)

Connects the PX3 to your KX3 (See Figure 2 on page 8 or Figure 3 on page 9).

⚠ Do not substitute different or longer cables for the PX3CBL set supplied. Doing so may degrade the performance of your PX3. See *PX3 Compared to the P3 and PC-Based Panadapters* on page 34 for details.

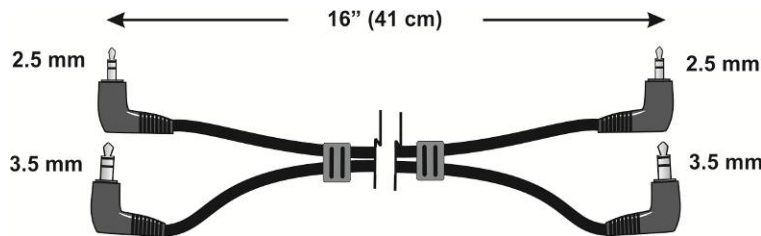

DC Power Cable (E850524)

Connects the PX3 to your 9 to 16 Vdc power supply with tinned leads to connect to your power supply. Optionally you can purchase the PX3 DC Power Supply that plugs into a mains outlet as shown below. Order the (PWR121A-US).



The optional power supply comes with a right angle extension (PWR2.1RA)

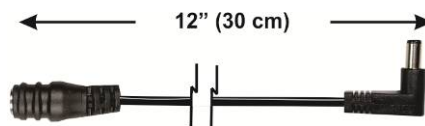

Quick-Start Guide

To get started using your PX3 right away, please read this page and the pages that follow, to connect your PX3 to your KX3 and explore the features and controls.

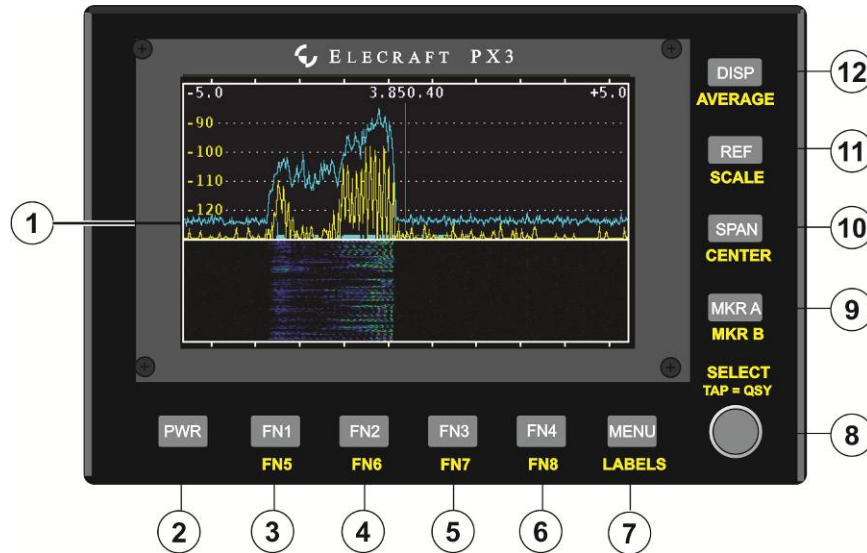



Figure 1. PX3 Front Panel.

<p>Prepare your KX3</p>	<ul style="list-style-type: none"> • Ensure your KX3 is equipped with Firmware version 2.19 or later: See your KX3 Owner’s Manual for information about checking and updating the firmware if needed. • In the KX3 menu, set <i>RX I/Q: On</i> and exit the menu.
<p>Setup and Connections</p> 	<p>Position the KX3 and PX3 as shown in the photograph on the cover, with the PX3 on the left side of the KX3. This keeps the PX3 away from the RF fields around the KX3’s antenna connectors that can interfere with the PX3. Do not substitute longer cables for the PX3CBL set provided. Doing so may allow noise pickup from various sources, including switching power supplies, 60-Hz AC, ground loops, and interface cables. You can pass the PX3CBL cables connecting the KX3 and PX3 under or behind the PX3.</p> <p>⚠ When adjusting the legs to position on your PX3, be sure the thumb screws are loose. They thread into the legs, and forcing a leg into position without loosening the thumb screw may tighten the thumb screw so much it becomes very difficult to loosen.</p> <p>Connect a dc power supply to the 9-16 VDC input jack on the PX3 side panel (see <i>Specifications</i>, page. 10 for more about the power requirements). A power cable with a right angle 2.1 mm barrel connector is supplied. Connect the wire with the white strip to the positive (+) terminal on your power supply. If you purchased the optional PWA121V1A-US power supply for your PX3, plug it into a 100 to 240 volt mains outlet. It is provided with a right-angle cable adapter (PW2.1RA) that you can use for a neater cable installation.</p> <p>⚠ We recommend that you turn off the external supply before connecting power to the PX3. Some power connectors have an exposed center terminal that can create a short circuit if it touches the metal ground when it is being inserted.</p> <p>If your KX3 installation includes the Elecraft KXPA100 amplifier connected using the KX3 to KXPA100 Adapter Cable, connect the PX3 as shown in Figure 3 on page 9.</p> <p>If you do not have the KXPA100 and adapter cable, connect the PX3 as shown in Figure 2 on page 8.</p>

<p>The Basics</p>	<p>⚠ TAP AND HOLD: Most PX3 switches have two functions, similar to the KX3. <i>Tap</i> (press briefly) to activate the function labeled <i>on</i> the switch. <i>Hold</i> (press for 1/2 second) activates the function labeled <i>below</i> the switch. In the text, tap functions are shown like this: DISP while a hold function is shown like this: AVERAGE. Additional typographical conventions are shown on the previous page.</p> <p>The controls and indicators shown in Figure 1 are identified by the circled numbers in the following text (e.g. ① refers to the display screen).</p> <ul style="list-style-type: none"> • Apply power to the PX3 and hold PWR ② to turn it on. • Tap DISP ⑫ to cycle between spectrum and waterfall display modes (Page 15). • Activating many functions enables the SELECT knob ⑧ so you can adjust the parameter associated with the function. The current parameter value is shown on the screen ①. You can exit and save the parameter by tapping the same key a second time, even for hold functions. • For hold functions, you can also hold the key a second time to exit parameter-entry mode. Holding the four keys along the right edge of the front panel ⑨,⑩,⑪,⑫, a second time de-activates the function itself. For example, holding CENTER ⑩ a second time returns the display center frequency to the transceiver frequency and holding MKR B ⑨ a second time turns off marker B.
<p>Other Features</p>	<ul style="list-style-type: none"> • Tap MENU ⑦ and use the SELECT knob ⑧ to scroll through the menu. • Tapping the SELECT knob ⑧ while the menu is active causes the currently-selected menu function to execute. For example, select <i>LCD Brt</i> from the menu and tap the knob. The knob now adjusts the brightness of the LCD display backlight. Tap the knob again to exit the selection or tap MENU ⑦ to select a different menu item. Some menu items are toggle functions. Instead of changing the parameter by turning the SELECT knob, it changes automatically whenever the knob is tapped. The new value is displayed briefly near the top of the spectrum display. Menu items are listed on page 30. • As you become familiar with the menu options, you may find that you want to adjust certain items frequently. You can assign up to eight menu items to the function keys ③,④,⑤,⑥. Tap FN1 through FN4 or hold FN5 through FN8 to assign the function key to a menu item while the menu item is displayed. • Hold LABELS ⑦ to display the labels you have assigned to the switches (page 15). They are displayed at the bottom of the screen, just above the function keys (Pages 12 and 13). Hold LABELS again to toggle the labels off. • Tap MKR A or hold MKR B ⑨ to turn on marker A or B. Rotate the SELECT knob to place the selected marker at a desired frequency on the display. Markers may be used to measure the frequency of an interesting signal and tapping the SELECT knob will QSY (change the frequency of) the KX3 to that frequency. MKR A controls the KX3's VFO A and MKR B controls VFO B. The marker colors match the corresponding VFO cursors to emphasize the correspondence. Whichever marker is currently selected is the one that causes the KX3 to QSY (Page 12). • To return from the last QSY to the original frequency ("undo" function), <i>hold</i> the SELECT knob pushbutton while the marker is selected. • To turn off the markers, tap MKR A while marker A is selected or hold MKR B while marker B is selected.

- Tap **SPAN** (10) to set the frequency span of the display. The start and stop frequencies are displayed at the top (left and right edge respectively) of the spectrum window (Page 13).
- Hold **CENTER** (10) and turn the **SELECT** knob set the center frequency of the display (Page 13). This function may be disabled by selecting *MENU:CenterEn* and tapping the **SELECT** knob pushbutton to toggle between *CENTER Key ON* and *CENTER Key OFF*.
- Tap **REF** (11) to set the amplitude reference level of both the spectrum and waterfall displays. The reference level is the signal level corresponding to the bottom of the spectrum display (Page 13).
- Hold **SCALE** (11) to set the scale, or signal amplitude range, of both the spectrum and waterfall displays. For example, *Scale (dB): 60* means that the bottom of the display is 60 dB below the top (Page 13).
- Hold **AVERAGE** (12) to turn on display averaging and allow adjustment of the averaging time by turning the **SELECT** knob (Page 13).

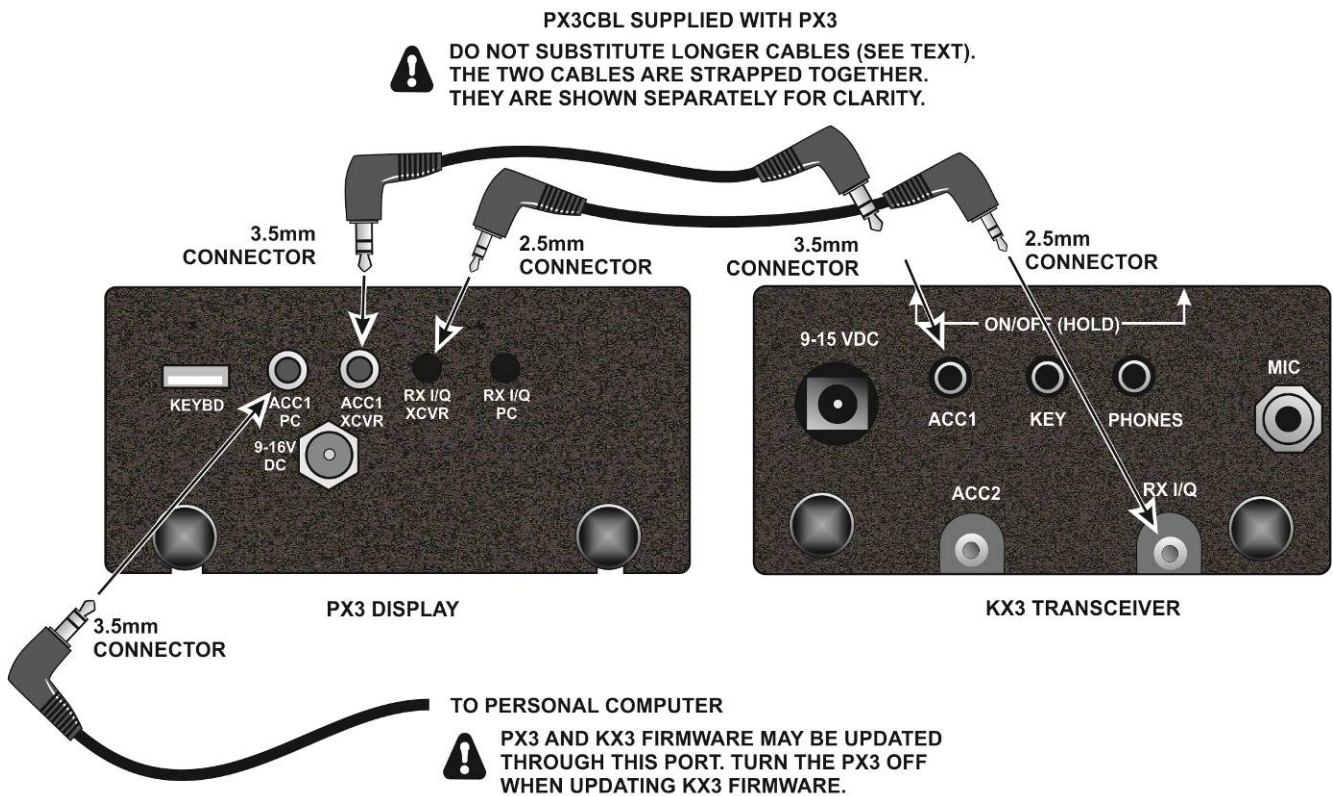
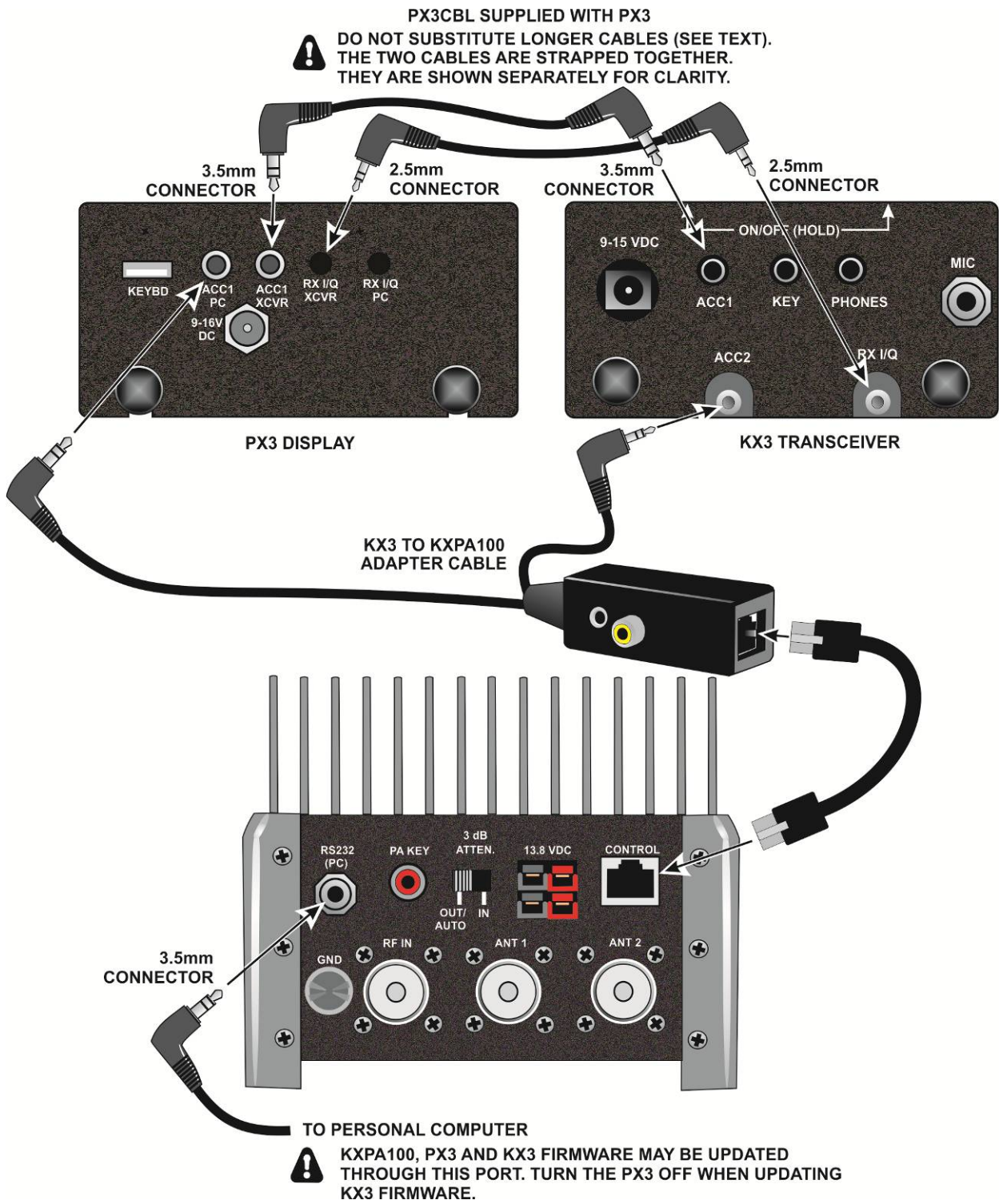

Figure 2. Basic KX3-PX3 Cabling.



⚠ When used with the KXPA100 Amplifier as shown here, the PX3 RS232 data rate must be set to 38400 baud (see menu entry RS232 on page 31).

Figure 3. PX3 Signal Cabling with KXPA100 Amplifier and KX3 to KXPA100 Adapter Cable.

Introduction

This comprehensive manual covers all the features and capabilities of the Elecraft PX3 panoramic display. We recommend that you begin with the *Quick-Start Guide* (page 6). The *Front Panel* (page 11) and *Side panel Connectors* (page 14) sections are for general reference. *Basic Operation* (page 15) and *Advanced Operating Features* (page 22) fill in the details of the full capabilities of the PX3.

PX3 Features

The PX3 Integrates very closely with the Elecraft KX3 with point-and-click QSY and an “undo” feature with simple control press to return to the previous frequency. A number of advanced features enhance the PX3’s performance and versatility:

Easy Set-Up

- Only three cables for basic operation (I/Q for signal, ACC1 for frequency data and power). Cables are provided with the PX3.
- Optional additional connections provided for transceiver communications, a personal computer and optional accessories.
- Simple configuration and calibration for optimum performance with your KX3.

Display

- Bright, high-resolution, full color display.
- Efficient LED backlight for long life and low power consumption.
- The frequency display tracks the KX3.
- Both Spectrum and Waterfall displays.
- Fast display update.
- Up to 200 kHz span.
- Frequency resolution automatically increases as span is decreased.
- Excellent sensitivity and dynamic range.

Ergonomic Design

- Uncluttered interface.
- No unused controls on the screen.
- Adjustable legs to match the viewing angle of the KX3.

Field Upgradable

The PX3 employs software defined architecture so many new features will require only a simple firmware update using the PX3 utility program. The PX3 utility program can be downloaded from www.elecraft.com.

Front Panel

This section describes all front panel controls and the liquid crystal display (LCD). Operating instructions are covered in later sections.

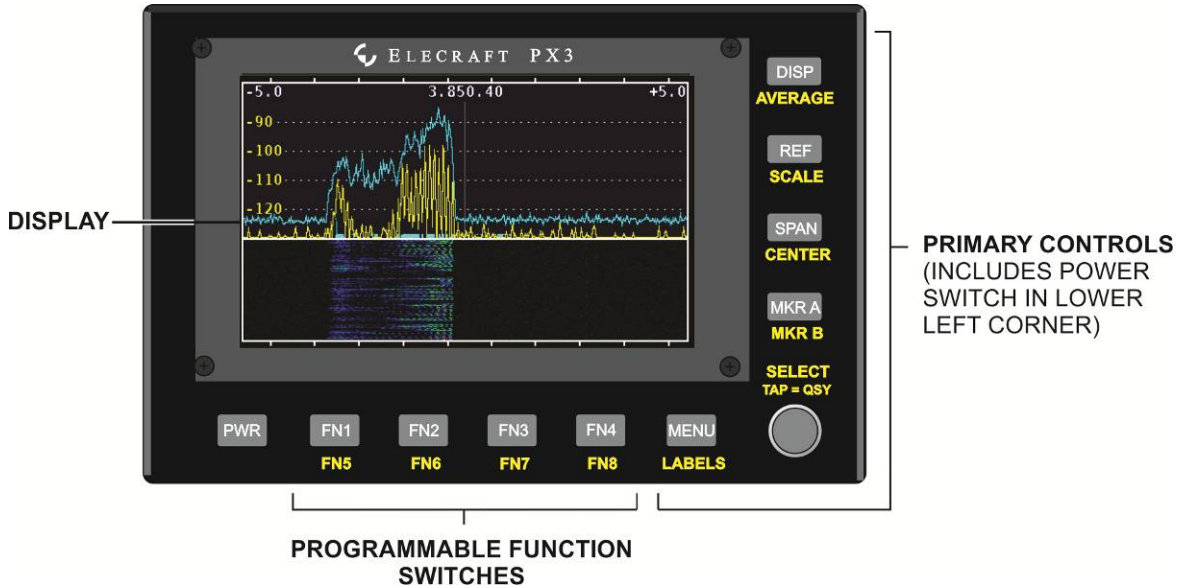

Figure 4. PX3 Control Groups.

Control Groups

Primary Controls (see page 12): These switches are hard-coded with permanent function assignments. They provide the most important operational features needed for basic panadapter operation, including display options, amplitude scaling, frequency control and markers.

Programmable Function Switches (see page 13): The function keys may be assigned to any of the functions in the **MENU** list. These include less-used operational features, test functions, and setup and calibration routines.

Display

The 480x272-pixel, color TFT-LCD display is used both for the panadapter spectrum and waterfall graphics as well as for general-purpose information needed by the operator. All graphics and text are

bit-mapped and so are software-defined. The display brightness and the text size can be changed via **MENU** entries (Page 30).

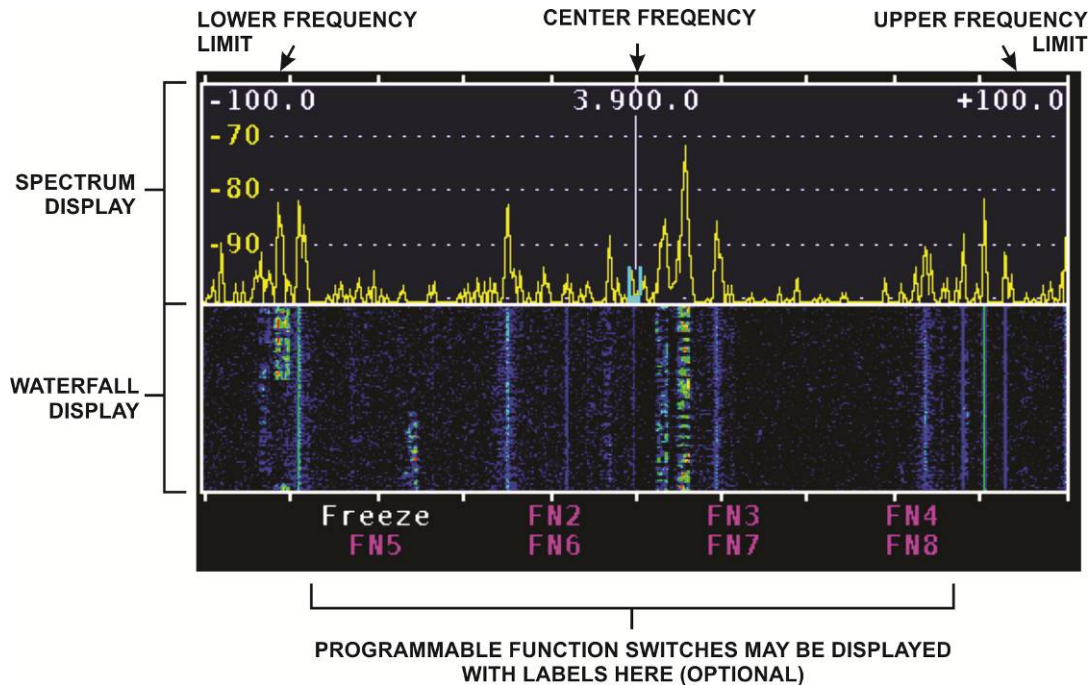

Figure 5. PX3 Display.

Primary Controls

PWR turns the PX3 on or off. The PX3 may be configured to turn on automatically whenever power is applied by moving a jumper inside the PX3 enclosure (see *Configuring the Power Switch* on page 22 for details). Holding the **PWR** switch for more than 20 seconds places the PX3 in boot-load mode, ready to receive new firmware. If you do this accidentally, simply cycle the **PWR** off, then on again to restore normal operation.

MKR A and **MKR B** each cause a marker to appear on the display, using different colors for A and B. **MKR A** controls the KX3's VFO A and **MKR B** controls VFO B. The marker colors match the corresponding VFO cursors to emphasize the correspondence.

The \odot symbol next to the marker frequency means the frequency can be adjusted by selecting it with the **MKR A** or **MKR B** switch and turning the

\odot **SELECT** knob. Tapping the \odot **SELECT** knob changes (QSY) the frequency of the corresponding KX3 VFO to the marker frequency. To undo the QSY and return to the original VFO frequency, select the marker and *hold* the \odot **SELECT** knob pushbutton.

To turn off markers, tap **MKR A** while marker A is selected or hold **MKR B** while marker B is selected. When a marker is turned back on after having been turned off, it will come back at the same frequency unless it is off-screen, in which case the marker defaults to the center frequency.

When another function that uses the \odot **SELECT** knob is activated, the marker(s) will stay visible and when that other function is de-selected the last active marker automatically becomes active again.

SPAN sets the frequency span of the display. The available range is 2 kHz to 200 kHz. The start and stop frequencies are displayed at the top (left and right edge respectively) of the spectrum window. For example, a 200 kHz span will be displayed with -100.0 in the upper left and +100.0 in the upper right corners.

CENTER sets the center frequency of the display, which is also displayed at the top center of the spectrum window. The center frequency of the display may be offset from the KX3's frequency with the **SELECT** knob. The center frequency will then track changes in the KX3's frequency, maintaining the same offset.

Hold **CENTER** a second time to return the center frequency to the KX3's VFO A frequency.

This function is disabled if *MENU:CenterEn* is set to *OFF*.

REF sets the amplitude reference level of the display, both spectrum and waterfall. The reference level is the signal level in dBm that corresponds to the bottom of the spectrum display and the minimum (dark blue) signal level of the waterfall display. The amplitude labels that appear along the left edge of the spectrum display may be in S-units plus dB over S9 or dBm, depending on the setting of *MENU:Lvl Mode*. The KX3's attenuator and preamp have no effect on the displayed amplitude when dBm is selected, but the effect of the attenuator and preamp will be seen when the display is in S-units.

SCALE sets the scale, or range, of both the spectrum and waterfall displays. For example, Scale (dB): **60** means that the bottom of the display is 60 dB below the top.

DISP toggles between the spectrum, and combination spectrum/waterfall display modes.

AVERAGE allows you to turn on and adjust display averaging. The averaging is adjusted in units of display update periods. For example, Averaging time: **20** means the display is averaged over every 20 update cycles. Tap **DISP** to exit the average parameter adjustment mode while maintaining the selected averaging period. Hold **AVERAGE** to turn off averaging.

Menu

MENU accesses an alphabetical list of functions (see *Menu Functions*, page.30). Scroll through the list with the **SELECT** knob and tap the knob to select an item. For items with only two or three values, tapping the **SELECT** knob toggles between the parameter values. For other items, turn the **SELECT** knob to choose the parameter value. Tapping the **SELECT** knob a second time unselects the item and exits the menu. If you wish to terminate the item but keep the menu active, tap **MENU**. When you wish to exit the menu, tap **MENU** again.

Programmable Function Keys

Most menu functions can be assigned to a function key by tapping **FN1** through **FN4** or holding **FN5** through **FN8** while the menu item is displayed but not selected. When a menu function is selected, the text on the screen prompts you to either tap the knob to select it or a FN key to assign it to the key.

If a function was previously assigned to a key, assigning a new function over-writes the original function.

LABELS displays the function assigned to each key. Keys identified with the label FN number have not been assigned to a menu function. **LABELS** toggles the function key labels on and off. Note that the function keys are still active even when the labels are turned off.

Side Panel Connectors

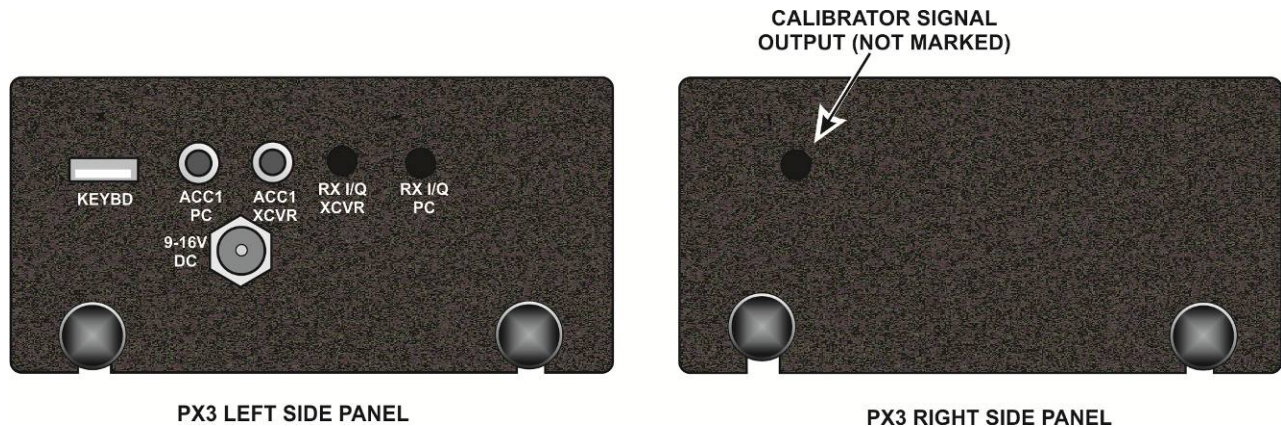

Figure 6. PX3 Side Panels.

⚠ See Figure 2 on page 8 or on page 9 for normal cable interconnections between the PX3 and KX3. The following describes the function and pin-out of each connector.

Power: 9-16 VDC is a standard 2.1 mm barrel connector for dc power. The center pin is the positive (+) connection.

ACC1 PC is a 3.5 mm stereo jack that allows firmware updates, configuration, and remote control of the PX3 and KX3 via a personal computer. The tip connection is RX data coming from the computer and the ring is data going to the computer. If needed, suitable cables for either a USB or RS232 computer interface are available from Elecraft (see *Firmware Upgrades* on page 24 for more information).

ACC1 XCVR is a 3.5 mm stereo jack that allows communications between the PX3 and the KX3. When the PX3 is turned off, data applied at ACC1 PC passed directly through the PX3 to the ACC1 XCVR connector. The tip connection is RX data going to the KX3 and the ring is data coming from the KX3.

RX I/Q XCVR is a 2.5 mm stereo jack that receives quadrature outputs from the KX3 receive mixer (I=in-phase, Q=quadrature).

RX I/Q PC is a 2.5 mm stereo jack that provides the quadrature (I/Q) outputs from the KX3 to a personal computer. If you had a I/Q connection directly to the KX3 before installing the PX3, this connector feeds the same signals through to your computer with the PX3 installed.

KEYBD is for future use.

CALIBRATOR SIGNAL OUTPUT on the right side panel is a single pin output that provides a signal required to adjust the opposite sideband nulling for your KX3 (see page 25).

Basic Operation

⚠ These instructions assume that you have firmware revision 2.25 or later installed in your KX3 and firmware revision 1.15 or later installed in your PX3. See *Firmware Upgrades* on page 24 if you need to update your firmware.

This section covers the fundamentals of PX3 operation. Once you're familiar with the PX3, please go on to *Advanced Operating Features* (page 17).

Using Tap/Hold Switches

Most PX3 switches have two options. **Tapping** (pressing for less than 1/2 second) activates the function labeled in white on the switch. **Holding** (pressing for more than 1/2 second) activates the function labeled in yellow below the switch except for the Power switch which has only the one function. The **PWR** switch requires a hold to turn the PX3 on but only a tap to turn the PX3 off.

Initial Power-Up

- Connect your PX3 to the KX3 as shown in Figure 2 on page 8 or Figure 3 on page 9.
- Apply power to the KX3 and enable operation with the PX3 in the KX3's menu: **MENU: RX I/Q On**
- Press **PWR** to turn the PX3 on, if it is not on already. The screen should light and you should see a spectrum or combined spectrum and waterfall display. If a KX3 is connected via the ACC1 cable you should see the correct frequency at the top center of the display.

Configuring the Display

Tap **DISP** to cycle between spectrum and combined spectrum and waterfall displays.

Hold **AVERAGE** to turn on averaging and to set the averaging time constant with the **SELECT** knob.

You can hold **AVERAGE** again to turn off averaging or just tap the same switch to clear the parameter-entry text from the display while leaving averaging enabled.

Hold **LABELS** to show or hide the function switch labels.

There are also several menu functions that configure the display, such as *LCD Brt* (display brightness), *Peak hold*, *Freeze display*, *Font size* and *Waterfall height*.

Using the Menu

- Tap **MENU** to access the menu. The menu will appear near the top of the display.

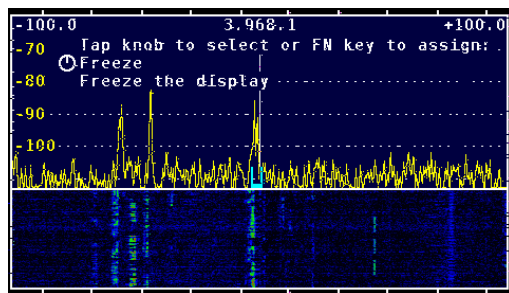

Figure 7. Typical Display Showing a Menu Selection.

- Turn the **SELECT** knob to scroll through an alphabetical list of available menu functions, as documented in the Menu Functions section (page.30).
- Tap the **SELECT** knob to select a function.
- Most functions have a parameter which can then be changed with the **SELECT** knob. Those functions all start with the **SELECT** symbol on the display.
- Tap the **SELECT** knob again to exit the function.
- Tap **MENU** again to exit the menu.
- Some menu items are toggle functions. The parameter changes automatically every time you tap the **SELECT** knob.

Programmable Functions

Most menu functions can be assigned to any programmable function switch, FN1 to FN8 to allow quick access without using the menu. Common examples of such functions you may wish to access quickly are *Peak* hold and *Freeze* display. Tap or hold the desired function switch while the function is visible on the display but *not* selected by tapping the **SELECT** knob. The function name then becomes the function switch label which can be seen if labels are currently displayed.

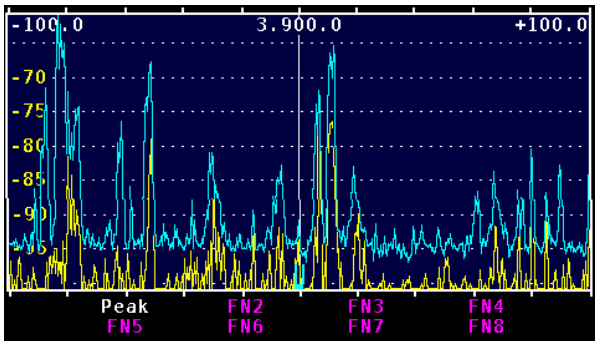

Figure 8. PEAK assigned to Function Switch FN1.

Assigning a function to a previously-assigned key overwrites the previous function. Optionally you can remove any assignment from a function switch with *MENU:FN Erase* and tap or hold the function switch you wish to erase.

Adjusting the Amplitude

Tap **REF** to adjust the reference level, which is the signal level that corresponds to the bottom of the spectrum display and the low-signal level of the waterfall display. Hold **SCALE** to adjust the "vertical gain" of the display. For example if the reference level is set to -100 dBm and the scale to 30 dB, then the top of the spectrum display is at -70 dBm and the bottom at -100 dBm.

The waterfall display is most useful if the reference level is adjusted to place the noise level near the bottom of the display and the scale is adjusted so that the strongest signals of interest are near the top.

Adjusting the Frequencies Displayed

Tap **SPAN** to adjust the range of frequencies that can be seen on the display at one time. The start and stop frequencies in KHz are indicated at the top left and right of the display. They are shown as offsets from the center frequency.

Hold **CENTER** to adjust the display center frequency by turning the **SELECT** knob. The center frequency of the display is now offset from the KX3's VFO A frequency by the amount shown. The center frequency will then track changes in the KX3's frequency, maintaining the same offset.

Hold **CENTER** a second time to return the center frequency to the KX3's VFO A frequency.

The center function may be disabled in the menu: *MENU: CenterEn*. Press the **SELECT** knob to toggle the function on or off.

Hold **CENTER** again to re-center the display on the transceiver VFO frequency.

The tic marks that appear along the top and bottom edges of the spectrum and waterfall widows indicate RF frequency in integer multiples of 0.5, 1, 2, 5, 10 or 20 kHz, depending upon the span.

Using Markers

Tap **MKR A** to turn on marker A and allow you to change the marker frequency by rotating the **SELECT** knob. To determine the frequency of a signal, move the marker so that it overlays the carrier and read the frequency from the display. For single sideband signals, place the marker where the carrier would be if it were transmitted, i.e. on the lower frequency (left) edge of an upper sideband signal and on the upper frequency (right) edge of a lower sideband signal.

You can QSY (change the frequency of) the KX3's VFO A to the marker A frequency by tapping the **SELECT** knob. To return to the previous frequency, hold the knob. To turn off marker A, tap **MKR A** again.

Similarly, marker B is turned on and off with the **MKR B** switch and you can change the marker frequency with the **SELECT** knob. Tapping the **SELECT** knob changes the KX3's VFO B frequency in the same way **MKR A** changes the VFO A frequency

To turn off a marker you must first make it active, if necessary, by tapping **MKR A** or holding **MKR B**. Then tap or hold the switch a second time to turn off the marker.

If some other function that uses the **SELECT** knob is activated, the marker stays on and automatically becomes active again (you can adjust it with the knob) when the other function is terminated. The tap-to-QSY function affects VFO A if marker A is active and VFO B if marker B is active.

When a marker is turned on, it will be at the same frequency as the last time it was on unless that frequency is off-screen. In that case the marker is automatically reset to the display center frequency. (If you lose a marker off-screen, just turn it off and on again to return it to the center frequency.)

When you change bands on the KX3, the markers are automatically set at the new center frequency.

Waterfall Markers

Select **MENU: WfallMkrs**. Tapping the **SELECT** knob will turn the waterfall markers on, causing the marker line(s) to travel down into the waterfall display, or turn the markers off.

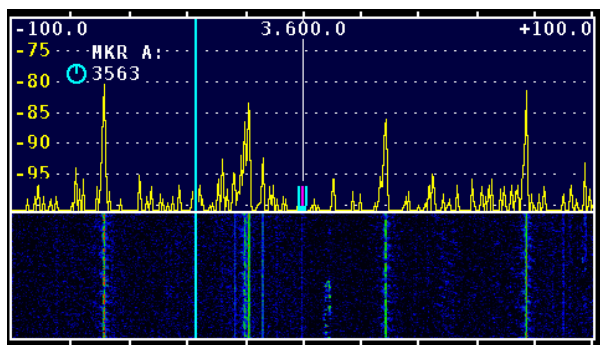

Figure 9. Marker A Enabled at 3563 KHz for Both Spectrum and Waterfall.

Using Cursors

Cursors show the position of the KX3's A and B VFOs. The position and width of each cursor shows the passband being received. Two cursor shapes may be selected using **MENU: Cursor**. The translucent bar cursor or a "U" shaped cursor at the bottom of the spectrum display may be selected.

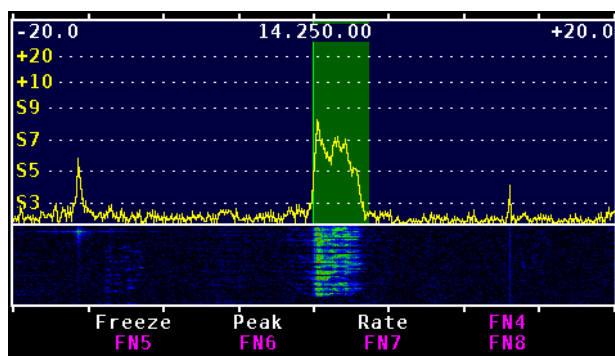

Figure 10. Bar Cursor on Upper Sideband Signal at 14.250 kHz.

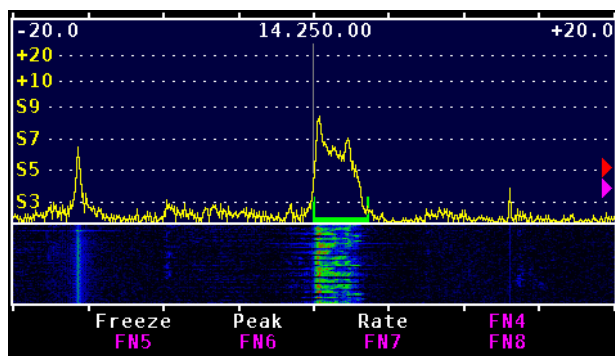

Figure 11. "U" Cursor on Upper Sideband Signal at 14.250 kHz.

VFO A has a green cursor and VFO B has a magenta cursor unless split mode is activated at the KX3. In split mode, the VFO B cursor changes to red as a reminder that you will transmit on that frequency. Similarly, if XIT is on, or if split is off and RIT is on, a new red cursor appears at the transmit frequency.

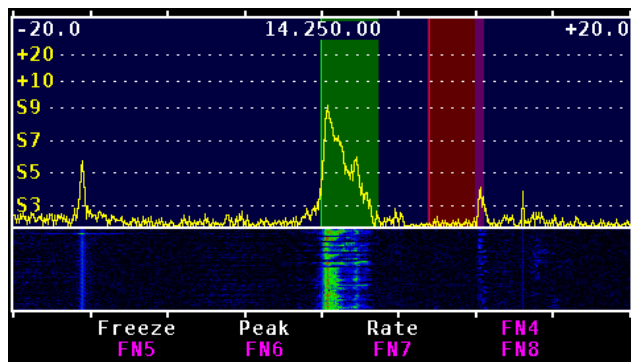

Figure 12. Red Bar Cursor Showing Transmit Frequency Above the Receive Frequency.

Whenever a cursor is tuned off-screen a small triangle of the same color appears at the bottom left

or right of the spectrum window to indicate the direction to the missing cursor

The VFO B cursor may be turned off using *MENU*: **⌚** *VFO B*. Tap the knob to select *VFO B ON* or *VFO B OFF* as desired.

Noise Blanker

The noise blanker reduces the effect of impulse noise on the display. Normally impulse noise will cause the display to jump up and down in amplitude. The noise blanker has no effect on the audio from the KX3.

Impulse noise frequently comes from such sources as the AC power line and unshielded automobile ignition systems.

Engage the noise blanker in the menu with *MENU*: **⌚** *NB En*. Tapping the **⊖** *SELECT* knob toggles the noise blanker on and off. When the noise blanker is enabled, NB appears near the upper right corner of the display after you exit the menu.

Adjust the aggressiveness of the noise blanker with *MENU*: **⌚** *NB Level* and turn the **⊖** *SELECT* knob. A setting of 1 is least aggressive and 15 is maximum. The higher the setting the more completely it blanks the pulse noise, but the more likely it will cause distortion of the desired signals and jumping of the display. Use the lowest value that does an adequate job. About 10 or 11 is a good starting point.

Note that the **REF** and **SCALE** settings have no effect on the noise blanker.

If there are one or more very strong signals within the PX3's displayed frequency range, the noise blanker will have a hard time detecting the difference between the unwanted pulses and the wanted signal. Narrow the **SPAN** and/or offset the **CENTER** frequency if possible to place the strong signals well outside the PX3's display frequency range.

Displaying Decoded Text

You can display text decoded by the KX3 in CW or one of the data modes in the lower part of the display. Figure 13 shows decoded text from a W1AW transmission. Transmitted text appears in the same window in green.

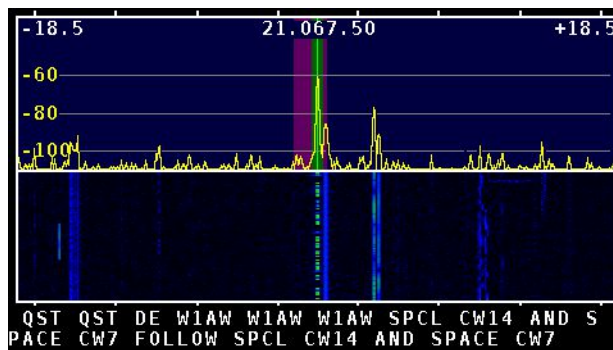

Figure 13. Decoded Text Display.

You have the choice of enabling the text display manually or having the PX3 automatically switch to text display when in the KX3 is switched to CW or DATA modes.

First set up the KX3 to decode the signal as described in your KX3 Owner's Manual. On the PX3, select *MENU*: **⌚** *Text menu* and then rotate the **⊖** *SELECT* knob to select *Txt Enb* (to turn text display on or off manually) or *TxtAuto*. to have text display turn on automatically whenever the KX3 is in CW or DATA modes. Tap the **⊖** *SELECT* knob to toggle the desired selection on or off.

When you first enable text display Text Display appears in the space and automatically clears when text is received or after a short delay.

⚠ Turn off text display before using the KX3 Utility in Terminal Mode to send and receive text. Trying to use both text display and the Utility in Terminal Mode will cause a data conflict in the PX3.

How to Set Up and Interpret the PX3 Display

There are several options to customize the layout of your PX3 display. **DISP** switches between a spectrum-only and spectrum-plus-waterfall display. The height of the waterfall can be adjusted with *MENU*: \odot *Waterfall*. The function (FN) switch labels appear at the bottom of the screen by default. You can hide them to maximize the screen area by holding **LABELS**. The FN switches remain active even when the labels are hidden. Another trick to maximize viewing area is to choose a smaller type font via *MENU*: \odot *Font*.

Spectrum Display

The spectrum display on a panadapter is similar to the display on a laboratory spectrum analyzer. The horizontal axis is frequency and signal strength is represented by the vertical height of each signal. The PX3's spectrum display is similar to most in that the signal height is proportional to the logarithm of the amplitude, represented in decibels (dB). Each 3 dB represents a doubling of power and 10 dB means ten times the power.

The vertical scale at the left edge of the spectrum display may be in units of dBm or S-units, as selected by *MENU*: \odot *Lvl Mode*. The dBm unit means decibels with respect to one milliwatt. 0 dBm is one milliwatt, +10 dBm is 10 milliwatts, -10 dBm is 1/10 milliwatt and so on. An S9 signal is normally considered to be 50 microvolts into 50 ohms, which is -73 dBm, an easy number for a ham to remember! Assuming the standard 6 dB per S-unit, the following table applies.

S-Units	Signal Level	
S9	-73 dBm	50 μ V
S8	-79 dBm	25 μ V
S7	-85 dBm	12.5 μ V
S6	-91 dBm	6.25 μ V
S5	-97 dBm	3.13 μ V
S4	-103 dBm	1.56 μ V
S3	-109 dBm	0.78 μ V
S2	-115 dBm	0.39 μ V
S1	-121 dBm	0.2 μ V

You would expect the S meter on the KX3 and the signal on the PX3 display to indicate the same level, however there are several reasons why that might not be the case. One is that the PX3 is not affected by the preamplifier and attenuator in the KX3 when the signal amplitude is shown in dBm.

The noise level will generally be lower on the PX3 display compared to the KX3's S meter. The reason is that the effective bandwidth of the PX3 is generally one display pixel, which is approximately the span divided by 450. The smaller the bandwidth, the less noise. For example, if the span is 45 kHz, the effective PX3 bandwidth is $45,000 / 450 = 100$ Hz. If the KX3 bandwidth is 400 Hz, it will show a 6 dB (one S-unit) higher noise level than the PX3.

A similar thing happens with spread-out signals like SSB. Even at the maximum 200 kHz span, the PX3's effective bandwidth is only about 440 Hz so that not all the SSB signal is within one pixel. That's why the PX3 tends to read a lower level on SSB signals than the KX3's S meter.

REF (reference level) on the PX3 shifts all the signals up or down. The level that you are adjusting is the signal level at the bottom of the display, measured in dBm.

SCALE is used to expand or contract the vertical scale. Think of it as a vertical gain control. The scale is defined as the dB difference between the top and the bottom of the display. For example, if the reference level is -100 dBm and the scale is 20 dB, then a signal at the top of the display is at -80 dBm. For both **REF** and **SCALE**, turning the knob clockwise makes the signals taller.

The PX3 automatically compensates for the preamplifier and attenuator in the KX3 when the display amplitude is shown in dBm. When you turn them on or off, the signal levels on the PX3 should stay the same. The indicated dBm level should be the signal level at the KX3's antenna input. Perhaps counter-intuitively, this means that if you turn on the preamplifier in the KX3, the noise level displayed on the PX3 may decrease, rather than increase. That is because the PX3 automatically reduces its gain when the KX3 preamplifier is turned on, in order to keep the signal levels the

same. When the PX3 display amplitude is shown in S-Units, the signal level will vary according to the preamplifier and attenuator settings, just like the KX3's S-meter.

Waterfall Display

The waterfall allows you to see a history of band activity for the past few seconds. Like the spectrum display, the horizontal axis is frequency but in this case the vertical axis is time. Signal amplitude is represented by colors, from dark blue for weak signals, then brighter blue as signals increase in strength, through shades of green, yellow and red for the strongest signals. Each horizontal line represents one update of the spectrum display. As each new line is written the old ones are shifted down, creating a waterfall effect.

While the spectrum display is better at accurately displaying signal strength and the shape of a signal's modulation, it can only show what is happening right now. The waterfall is better for showing transient signals, such as a DX station running a pileup that only transmits for a few seconds at a time. Often you can easily see a weak fading signal on the waterfall that is invisible on the spectrum display.

The scaling of the waterfall is the same as for the spectrum. That is, the bottom of the spectrum display corresponds to dark blue on the waterfall and the top corresponds to bright red. For maximum visibility of signals on the waterfall, it is best to set **REF** so that the noise level is right at the bottom of the spectrum display and then expand **SCALE** as much as possible while keeping signals of interest below the top of the spectrum display. That improves the color contrast on the waterfall and makes weak signals appear to pop out of the noise.

Averaging and Peak Hold

Another way to make weak signals more visible is averaging. Because noise is random in nature, averaging reduces the jaggedness of the noise spectrum trace, making signals easier to pick out. More averaging improves the noise reduction but at the expense of a slower response. To turn on averaging and adjust the averaging time, hold **AVERAGE** and then turn the knob. The averaging time is in units of the spectrum update rate, typically about 50 ms. You can apply averaging to

the waterfall as well by setting *MENU*: **Wfall Avg** to *On*.

Peak hold is a way to display a memory of past signals on the spectrum display. It shows the strongest signals that have appeared at each frequency since the last time peak mode was enabled. To reset the peak trace, simply disable peak hold and then re-enable it. This mode is most useful if you assign *MENU*: **Peak** to a FN switch so you can turn it on and off with a single touch.

One use for peak hold is to monitor a dead band for activity while you are away from the operating position. If you glance at the display every now and then you can see if any signals have appeared in the meantime. Peak hold is also useful to see the shape of a modulation spectrum. Since the sidebands are continually changing with modulation, the peak is a better indication of the spectrum than the instantaneous value.

Span

Adjusting the span is yet another way to make weak signals more visible. As you narrow the span, there is less noise within the range of each frequency display point. That reduces the apparent noise level while the signal levels stay the same, which increases the signal-to-noise ratio. At narrow spans, signals that are difficult or impossible to hear become visible, especially on the waterfall.

As mentioned before, it is useful to keep the noise level right at the bottom of the display. The PX3 can automatically keep the noise level constant as you adjust the span by setting *MENU*: **SpanScale: REF LVL only**. If you would also like the level at the top of the screen to remain constant as you adjust the span, set *MENU*: **SpanScale: REF LVL & Scale**.

Typical Spectra

Figure 14 is a typical screen shot of the 40 meter band during the day. At the center is a weak CW signal that was inaudible on the KX3 transceiver during fades. It is hard to see on the spectrum display at the top but is clearly visible on the waterfall. Just to the right of that is a strong interfering carrier. At the far right is another steady carrier and just to the left of that is a spurious emission, probably from a switching power supply, that is wavering back and forth in frequency. A

panadapter is a powerful tool for tracking down interference.

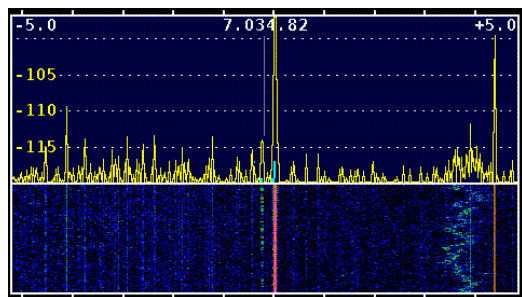

Figure 14. Typical Spectra Display.

Figure 15 is another example of interference, this time from a LAN router. The QRM includes both wideband noise as well as discrete carriers and is constantly heaving and writhing as the processor in the router executes different portions of its software routines.

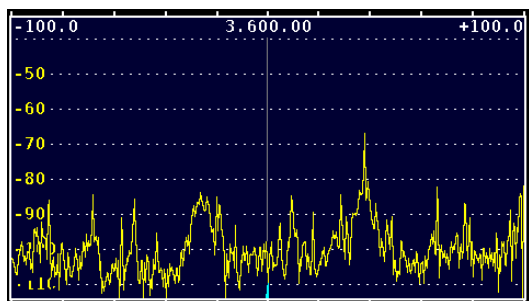

Figure 15. Typical Interference Display.

Spurious signals generated in the transceiver are sometimes visible as well. As you tune the transceiver you may see carriers that scroll across the screen much faster than other signals, sometimes tuning in the opposite direction. These are created by high-order harmonics of the VFO, BFO and other signal sources in the transceiver. Normally you won't hear them in the receiver unless one falls within the passband, but they are easy to see on the panadapter display because of its much wider bandwidth.

Figure 16 is a shot of a local AM broadcast station, illustrating the use of peak hold to show the shape of the modulation spectrum, which extends to plus and minus 10 kHz from the carrier and then drops off abruptly to meet FCC regulations.

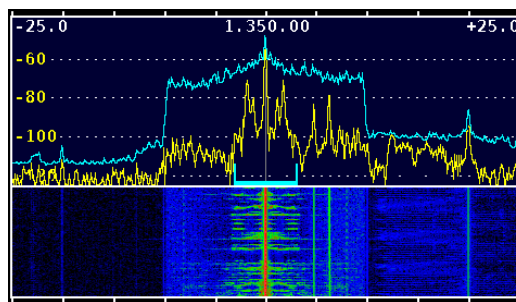

Figure 16. Typical AM Spectra using Peak Hold.

Normally the PX3 display is frozen while the KX3 is transmitting. However if you temporarily disconnect the ACC1 cable between the PX3 and KX3, that function is disabled and it is possible to view your own transmissions for test purposes. You may need to experiment with **REF** on the PX3 and the power level and on the KX3 to properly display the signal.

Figure 17 shows a typical LSB spectrum obtained in this way. Peak hold is enabled in order to get a better view of the spectrum shape. Notice that the low audio frequencies (on the right) are much stronger than the high audio frequencies. A flatter spectrum is considered desirable to improve the signal's "punch" in the presence of noise and interference, especially when speech compression is used. The PX3 is a handy tool for adjusting the transmit equalizer in the KX3.

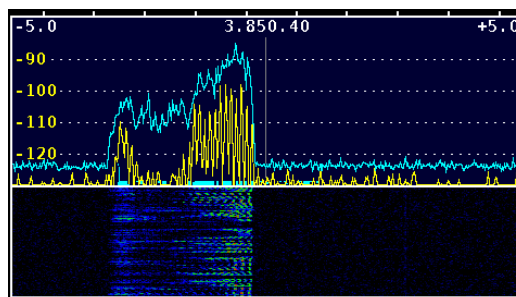

Figure 17. Typical SSB Spectra using Peak Hold.

Figure 17 also illustrates an important point when using markers. On SSB, the frequency that is shown on the display of the KX3 transceiver is the suppressed carrier frequency. When you QSY the transceiver using MKR A or MKR B on the PX3, where the marker is set is the frequency the KX3 will go to. So on bands where LSB is used, you should place the marker just above the spectrum of the SSB signal you are trying to net (approximately in the center of the above display) and for USB, place the marker just below the spectrum.

Advanced Operating Features

Remote-Control Commands

Many PX3 functions may be accessed by remote-control commands sent via RS232. These commands use ordinary ASCII text, so they can be tested using a terminal emulator or the Command Tester tab in PX3 Utility. When the PX3's XCVR RS232 port is connected to a KX3, then both PX3 and KX3 commands may be sent and received via the PC RS232 port.

To distinguish them from KX3 commands, PX3 commands begin with the “#” symbol. For example, “#RVM;” returns the PX3 firmware revision and “RVM;” returns the KX3 main firmware revision. PX3 remote-control commands are fully described in the *PX3 Programmer's Reference*.

PX3 Utility Program

In addition to downloading firmware (page 24) the PX3 Utility can perform several other functions. Refer to the Help menu in PX3 Utility for more information.

Configuration Save and Restore

Click on the utility program Configuration tab to Save or Restore PX3 Configuration data.

Command Tester

Click on the utility program Command Tester tab to enter commands, edit macros, etc.

Capturing Screen Displays

Click on the utility program Capture Image tab grab a bitmap image of the PX3 display which can be saved to a file or pasted into a graphics program on the computer.

Configuring the Power Switch

The front panel **PWR** switch may be bypassed so the PX3 turns on when power is applied.

To configure the power control, loosen the four thumb screws and remove the PX3 rear panel. The jumper is located near the edge of the Power Supply (PS) board as shown in Figure 18.

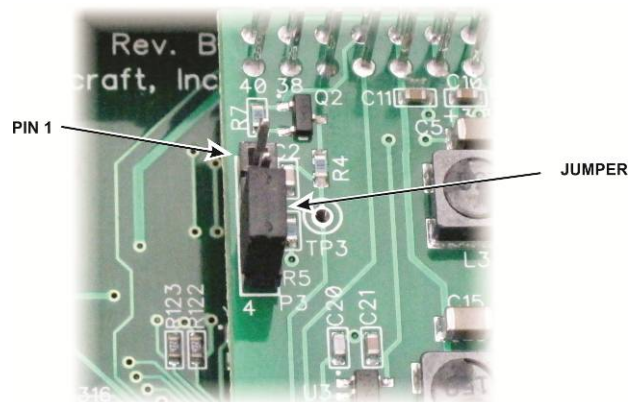

Figure 18. Power Control Jumper.

The jumper may be positioned on the pins as follows:

Pins 3 & 4: Normal operation of the **PWR** switch. The jumper is shown in this position in Figure 18.

Pins 1 & 2: **PWR** switch is disabled. PX3 turns on automatically and remains on as long as power is applied to the rear panel connector.



Even if bypassed so power is on all the time, the **PWR** switch is still used in the event it is necessary to put the PX3 in Boot Loader mode to force a firmware download. To cancel Boot Loader mode, remove power from the PX3.

Operation with Transverters

The following adjustments can be made independently for each transverter band.



Tuning Direction

When using an external transverter with the KX3 you may need to change the direction of the tuning so the frequency displayed is correct.

To configure the PX3 so the displays moves as expected, select *MENU:XV Invert*, tap the  **SELECT** knob, and turn the knob to select the transverter band in use. Tap the knob again and then turn the knob to either *Inverted* or *Not Inverted*. Tap the  **SELECT** knob to exit.

Amplitude Calibration for Transverters

You can calibrate a receiving or transmitting converter so the signal strengths are displayed correctly.

- Set up the PX3, a signal generator with a calibrated output, the transverter and the KX3 to obtain a signal on the display and with its peak centered vertically.
- Select *MENU:XV Gain*, tap the  **SELECT** knob, and adjust the knob to select the desired transverter band in use.
- Tap the  **SELECT** knob again, and adjust the knob to place the signal peak at the level corresponding to the output of your signal generator. Since most signal generators have outputs calibrated in dBm, you may want to switch the PX3 amplitude display to dBm (see *Spectrum Display* on page 19).

Firmware Upgrades

New features and improvements are available to all PX3 owners via firmware upgrades.

⚠ Be sure to check the release notes whenever you update your PX3 firmware. In the Utility Program, click on Help/PX3 Release Notes. Some updates require the KX3 firmware also be updated to function correctly.

The simplest and quickest way to upgrade your PX3 is with computer running Windows, Macintosh or Linux operating systems. If you don't have Internet access, you can obtain a firmware upgrade on CD. If you don't have a computer, you can send your PX3 to Elecraft to be upgraded. See *Customer Service and Support* on page 56.

Please visit the Elecraft KX3 software page (www.elecraft.com) to obtain our free firmware download application, *PX3 Utility*. Versions of the Utility program are available for all of the above Operating systems. The PX3 communicates with your personal computer through the ACC1 PC connector on the PX3 left side panel.

You can upgrade both PX3 and KX3 firmware through the same connector on the PX3. Simply turn the PX3 off before using the KX3 Utility program.

⚠ Some applications or peripheral devices may interfere with PX3 downloads; check the Help information in *PX3 Utility* if you have difficulty.

Checking your Firmware Revision

Use the *MENU*: \odot *FW Rev* to determine your firmware revision.

PX3 Firmware Self-Test

The PX3 checks for firmware errors at turn-on. If an error occurs, the PX3 Boot Loader is started

automatically. Connect the PX3 to your computer and reload firmware.

Forcing a Firmware Download

If you accidentally load an old or incompatible firmware version and find the PX3 unresponsive, do the following:

- (1) Turn the PX3 off. If necessary disconnect the PX3 from the power supply briefly.
- (2) With the power supply connected, hold the PX3's **PWR** switch; Boot Loader screen will appear on the display after about 10 seconds.
- (3) Load the correct firmware version.

Updating KX3 Firmware

If you have the PX3 ACC1 port connected to the KX3 ACC1 port, you can update your KX3 firmware without disconnecting the cables to the PX3. Switch the PX3 off. Turning the PX3 off automatically bypasses the PX3 so there is a direct connection between the computer and the KX3. If you have configured the PX3 so you cannot turn it off with the **PWR** switch (see *Configuring the Power Switch* on page 22), unplug the power connector on the PX3's side panel. Leave the PX3 off until the download is finished.

You need to turn the PX3 off only when downloading KX3 firmware. Otherwise you can leave the PX3 on while using the KX3 Utility. Note that you cannot display text on the PX3 and operate the KX3 Utility in Terminal mode to send and receive text at the same time. See *Displaying Decoded Text* on page 18.









Opposite Sideband Nulling

Complete nulling of the opposite (unwanted) sidebands depends upon accurate setting of the phase and amplitude of the I/Q outputs from the KX3. Although the PX3 comes with settings that should provide good suppression of the unwanted sideband, it may be possible to improve them if you wish.

The optimized Opposite Sideband Nulling settings will apply only to the specific KX3 and PX3 pair. If you use a different PX3 or connect your PX3 to a different KX3, they must be re-done for optimum suppression.

Getting Ready

A signal source with a variable level of about -40 dBm on each of the bands listed in Table 1 is required. The PX3 contains a built-in signal generator that is suitable or you can use an external signal generator such as the Elecraft XG3. If you use the built in signal generator in the PX3, set up the equipment with a coupling wire to introduce signal into the KX3 antenna as shown on page 29.

- Remove your microphone, keys, etc., that might be accidentally bumped to avoid transmitting into your signal source.
- You can save a lot of button-pushing by assigning the OSB Ampl (Opposite Side Band Amplitude) and OSB Phaz (Opposite Side Band Phase) menu functions to the function keys. For example, to use FN1 for OSB Ampl and FN2 for OSB Phaz as follows:
 - Hold **LABELS** to display the labels assigned to the FN keys.
 - Tap **MENU** and turn the  SELECT knob to  *OSB Ampl*, then tap **FN1** and note that the label for FN1 changes to OSB Ampl.
 - Turn the  SELECT knob to  *OSB Phaz*, then tap FN2 and note that the label for FN2 changes to OSB Phaz.
- Tap **MENU** (if you aren't still in the menu) turn the  SELECT knob to  *Lvl Mode* and tap the knob again to display dBm. Exit the menu.
- On the PX3 front panel, set the display parameters as follows:
 - **SPAN** :  50 (kHz).
 - **REF** :  130 (dBm)
 - **SCALE** :  80.0 (dB)
 - **DISP** : Tap to turn off the waterfall display.

- Before changing any settings, record the current amplitude and phase values in the initial settings columns for each band. You can use Configuration Backup in the PX3 Utility program (see page 22) or write the values on Table 1. This is important in case you want to return to the factory defaults. Tap the **BAND+** and **BAND-** switches on the KX3 to select each band and tap the **FN1** and **FN2** switches on the PX3 to display the OSB Ampl and OSB Phase values shown.

Table 1. 160 – 6 Meter Band Amplitude and Phase Settings.

Freq. MHz*	Initial Settings		New Settings	
	Ampl.	Phase	Ampl.	Phase
1.818				
3.6				
5.357				
7.20				
10.112				
14.063				
18.0				
21.429				
25.0				
28.125				
50.0				

* The frequencies shown are those generated by the PX3 internal calibrator. Any frequency near the middle of each band may be used.

- Skip this step if you do not use transverters with your KX3. If you have transverters installed, the settings obtained on the HF band the transverter uses for an I.F. may not be optimum because the tuning range the transverter requires may fall outside of the normal Ham band. If you have a suitable signal generator covering the input frequency range of your for each transverter, you can adjust the amplitude and phase for each transverter band. Those settings will not change the adjustments for normal H.F. operation on the band used as the I.F. Table 2 provides you a place to note and record the settings

Table 2. Transverter Amplitude and Phase Settings.

Transverter Adr	Frequency	Initial Settings		New Settings	
		Ampl.	Phase	Ampl.	Phase

⚠ Only adjust those transverter bands you actually use. There is no benefit in adjusting the other bands. The best frequency to use is the center frequency transverter tuning range.

- If you haven't done so already, connect your signal generator to the KX3 BNC antenna connector or set up the PX3 to use the internal signal source as shown on page 29. Set the signal generator for about -40 dBm output (if you are using the XG3 set it for -33 dBm output). If using the PX3 internal signal source, you can adjust the coupling to the KX3 antenna input for about -40 dBm as needed when you tune in the signal in the next steps.
- If using the PX3 internal signal source, turn on the signal with *MENU*: ⏸ *Cal Sig* and tap the ⏸ SELECT knob to display *On*.

⚠ The KX3 attenuator (ATTN) and preamplifier (PRE) may be either on or off because they have no significant effect on the strength of the test signal. For details about why this is so, see *How to Set Up and Interpret the PX3 Display* on page 19. Also, the KX3 antenna tuning unit (if installed) should not have an appreciable effect on the signal, but you can put it in bypass if you wish.

- Switch your KX3 to 160 meters and tune to a frequency 10 kHz *above* that of the signal generator. That is, if your signal source is at 1.818 kHz, tune the KX3 to 1.828 kHz. You should see a strong signal to the left of the center cursor and, if the opposite sideband is not completely suppressed, you will see a weaker signal the same distance to the right of the center cursor (see Figure 19). The weaker signal to the right is the opposite sideband. If you are using the internal PX3 signal source, adjust the coupling to the KX3 antenna input as needed for an easily visible signal level.

- Select OSB Phaz and adjust the \odot SELECT knob for minimum signal level of the opposite side band, then select OSB Ampl and adjust the knob for minimum. The controls interact, so switch back and forth until you have achieved minimum amplitude of the opposite side band (or it is buried in the noise). Always start by adjusting OSB Phaz.
- **i** If you have difficulty identifying the opposite sideband in the noise, momentarily unplug the I/Q connector to the PX3. That will cause the opposite sideband to be as strong as the main signal so you can identify exactly where it is on the display. Be sure to replace the connector before continuing with the adjustments.
- When you have the best null, record the numbers on the tables above for future reference.

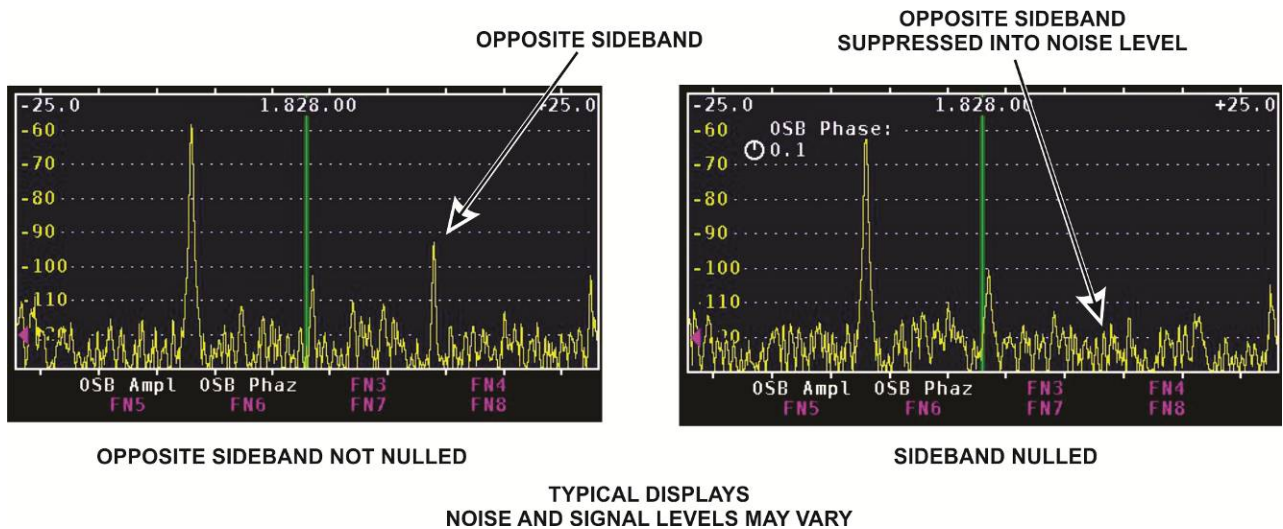

Figure 19. Typical Opposite Side Band Signal Displays.

- Repeat the procedure for each remaining band, adjusting the signal levels as needed for clear displays.
- **A** Be sure to tune the KX3 10 kHz above the signal generator frequency on each band.
- When finished, carefully remove the signal wire from the PX3 if you used its internal signal source, turn the calibrator signal off: MENU: \odot Cal Sig, tap the \odot SELECT knob to display off, and replace the rear panel.
- You can save the values you found for optimum other sideband suppression using the Utility Program to avoid needing to re-enter them from Table 1 or Table 2 should you ever need to reset your PX3 settings. See *Configuration Save and Restore* on page 22.
- **A** If you removed the PX3 rear panel to install the test pickup antenna, do not over-tighten the thumb screws on the rear pane when you replace it. If over-tightened, the screws can become very hard to remove.

Setting up the PX3 and KX3 to use the PX3 Internal Calibration Signal

On the PX3, loosen the four knurled thumb screws and remove the rear panel. Cut a length of insulated hook wire about 12 inches (30 cm) long. About 20 or 22 gauge will fit nicely. Pass it through the side panel opening in the PX3 and through opening in J103 as shown in Figure 20. Do not remove the insulation and do not push it through so far the exposed conductors at the cut end might contact components inside the PX3.

You can leave the rear panel off while doing the nulling procedure. Doing so will not affect the results.

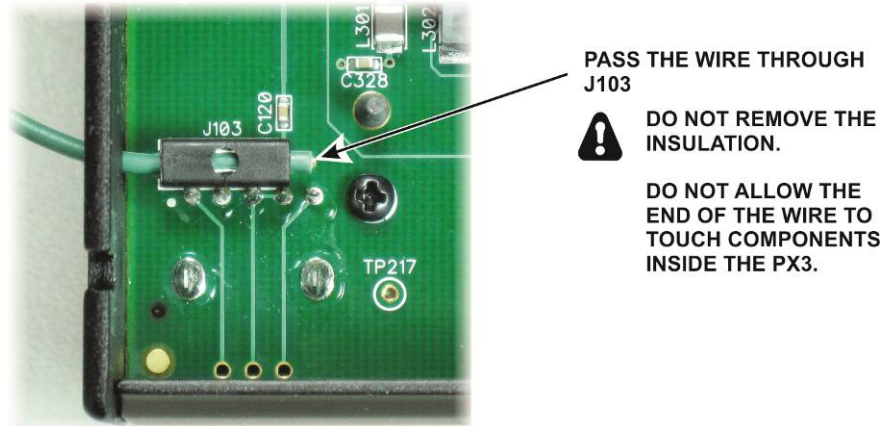

Figure 20. Calibrator Signal Pickup Wire Installed in the PX3.

Arrange the PX3 and KX3 as shown in Figure 21. Take care not to dislodge the pickup wire you installed in the PX3. Capacitively couple signal from the pickup wire to the KX3 as shown. Use enough wire to vary the capacitive coupling to the KX3 as needed by the nulling procedure.

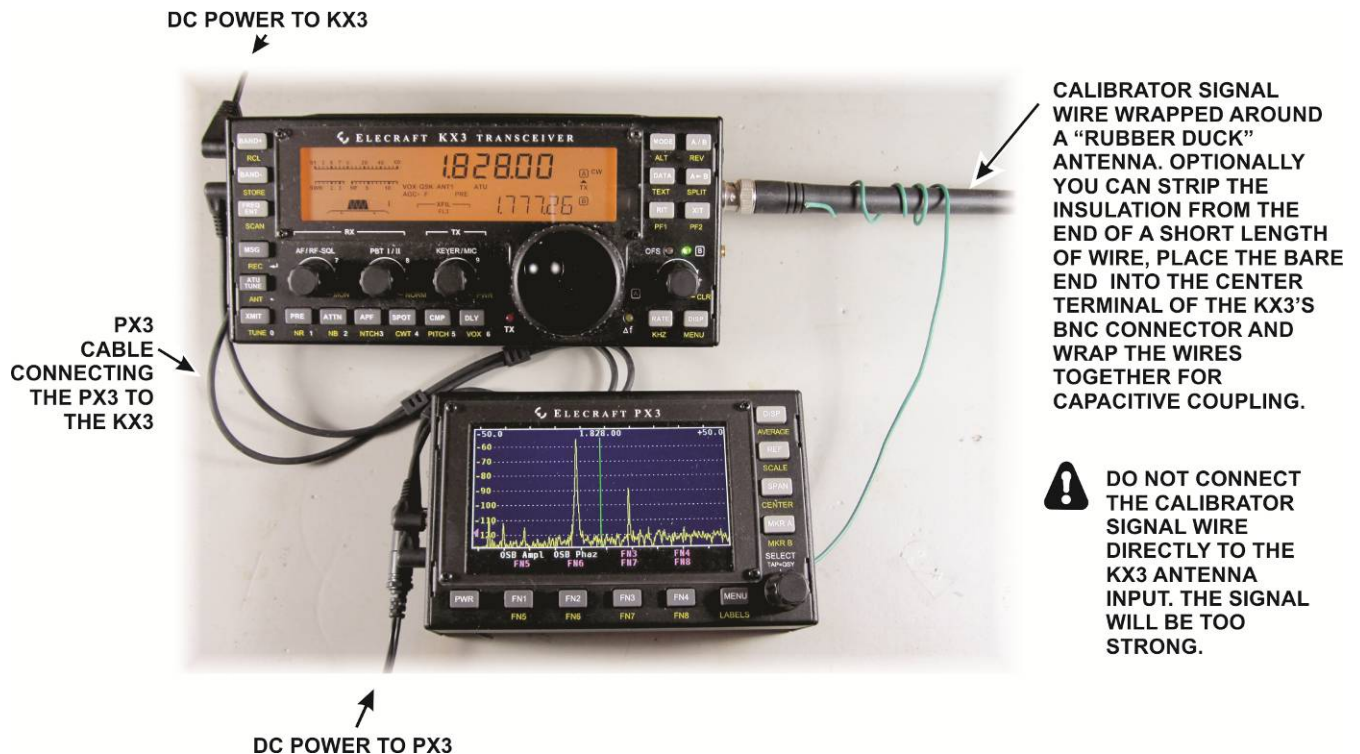











Figure 21. Opposite Sideband Nulling Setup Using Internal Signal Source.

Menu Functions

Tap **MENU** and then turn the  **SELECT** knob to scroll through the following list of menu functions. Tap the  **SELECT** knob to select the displayed function.

PX3 Menu

Entry	Default	Description
Cal Sig	Off	Enable/Disable Calibrator signal output.
CenterEn	Off	When OFF, the CENTER key does not adjust the center frequency.
Cursors	Bar	Bar produces a full height translucent bar on the spectrum display. “U” produces a U-shaped cursor at the bottom of the spectrum display.
DispTest	Off	Shows a test pattern with a color bar and the complete character set of each font. Tap MENU to exit.
Font	9 x 14	Changes the font size.
FN Erase	N/A	Resets a function key to its un-programmed state. Tap or hold the function key to be erased while this menu item is displayed.
Freeze	Off	Freezes or un-freezes the current spectrum and waterfall display. This function is most useful when assigned to a function key, which toggles between the frozen and un-frozen state.
FW Rev	N/A	Displays the main firmware version number. It is not necessary to tap the  SELECT knob for this function.
Knob Tap	N/A	When assigned to a function key, duplicates the  SELECT knob’s tap function.
Knob Hold	N/A	When assigned to a function key, duplicates the  SELECT knob’s hold function.
LCD Brt	100	Adjusts the display brightness from 0-100.
LCD Test	Off	Set all display pixels to white at full brightness.
Lvl Lines	Dotted	Select dotted or solid lines for the amplitude level graticule.
Lvl Mode	dBm	Select the amplitude level display units, either dBm or S-units plus dB over S9.
MKRA zero	N/A	Resets marker A to the center of the screen.
MKRB zero	N/A	Resets market B to the center of the screen.
NB En	Off	Turns noise blanker on and off.
NB Level	11	Sets the noise blanker level (see <i>Noise Blanker</i> on page 18).
OSB Ampl	0	Adjusts the I/Q amplitude balance (see page 25).
OSB Phaz	0	Adjusts the I/Q phase balance (see page 25).

Entry	Default	Description
Peak	Off	Toggles peak-hold mode on and off. This function is most useful when assigned to a function key.
Rate	80	Changes the display update rate in milliseconds. Although values down to zero may be entered, the minimum display period is actually limited by hardware.
Reset	N/A	Resets the PX3.
RS232	38400	Change the baud rate in bits per second of the serial port that connects to a host computer. During firmware download (via the PX3 Utility program), the baud rate is set automatically to 38400 baud, but it is then restored to the value selected in this menu entry.
SpanScale	REF LVL only	Specifies the way the PX3 responds to changes in SPAN. “Off” means do not change REF_LVL or SCALE when SPAN is changed. “REF LVL only” means change the reference level to keep the noise level approximately constant. “REF LVL & SCALE” means also change SCALE to keep the level corresponding to the top of the screen at a constant level as well.
Span Set	N/A	Tap or hold a function key to assign a current SPAN to that key. Once assigned the function key can be used to set the span with a single key press. The key label shows the span in kHz.
Step Span	Off	When Off, adjusting the SPAN occurs in 0.5 kHz steps for spans between 2 and 11 kHz, 1 kHz steps for spans between 11 and 102 kHz and in 2 kHz steps for spans between 102 and 200 kHz. When Step Span is On, adjusting the SPAN occurs in steps of 2, 5, 10, 20, 50, 100 and 200 kHz.
Sw Test	Off	Toggle switch test mode on or off. When on, a special test screen is displayed that shows the state of each switch and the current encoder count. Tap the  SELECT knob twice to exit.
Text Menu	Off	Tap  SELECT and then turn the knob to choose between Txt Enb (text enable) and Txt Auto (text automatically enabled when the KX3 is in Data or CW modes). Tap the  SELECT knob to toggle the desired mode on and off. See <i>Decoding Text</i> on page 18 for details.
VFO B	On	Turns the VFO B cursor on or off.
Waterfall	100	Changes the height of the waterfall window when the display is in waterfall mode.
Wfall Avg	Off	Enables or disables application of averaging to the waterfall display
Wfall Clr	Default Colors	Selects either color or gray scale (no color).
WfallMkrs	Off	Enables or disables markers on the waterfall display.
XV Gain	1	Calibrate the gain of the transceiving converters (transverters) used with the KX3 (see page 23). Stores separate values for each of the transverter bands.
XV Invert	--	Specify the tuning direction of the intermediate frequency bands used for transceiving converters. First tap the  SELECT knob to select the transverter band, and then turn the  SELECT knob to choose “Inverted” or “Not Inverted” (see page 23).

Troubleshooting

The most common symptoms and their causes are listed below.

Power On/Off Issues

Can't turn power off. The most likely cause is the power turn-on jumper located on I/O board is set incorrectly. See *Configuring the Power Switch* on page 22.

PX3 BOOT LOADER appears on the screen instead of the normal display. Occurs if **PWR** is held for more than 20 seconds. To correct, cycle **PWR** off, the on again. .

"FAILED CHECKSUM" message appears in the "PX3 BOOT LOADER" screen. Main PX3 firmware is not present or corrupted. Use PX3 Utility to download new firmware (see page 24).

"DOWNLOAD FIRMWARE, READY FOR DOWNLOAD" message appears in the "PX3 BOOT LOADER" screen. Either cycle power to return to normal operation or use PX3 Utility to download new firmware (see page. 24).

Display Issues

Wrong Center Frequency or no Frequency Displayed: Be sure the cable between ACC1 XCVR on the PX3 and ACC1 on the KX3 is installed. Hold the **CENTER** key to select the center frequency adjustment and then hold it again to re-tune the PX3 center frequency to the KX3 VFO A frequency. If Center Disabled appears on the screen enable it: *MENU:CenterEn* and tap the  **SELECT** knob to obtain CENTER key ON.

Unexpected Signals Displayed or Signals Appear in Two Places: If a signal on the left side of the display is also visible equidistant on the right side, check to be sure the I/Q cable between the KX3 and PX3 is fully seated at both ends. Unplug and plug in the cables at both ends. Also see *Opposite Sideband Nulling* on page 25. Try turning the PX3 noise blanker off (see page 18), adjusting its setting or reducing the KX3's gain. Turn the PX3 off, then on again to restart its firmware.

Display Noise Floor Jumps Up and Down: PX3 noise blanker (see page 18) may be turned on and set to high for the band conditions causing signal artifacts. Signal level from the KX3 may be too high. Try turning off the KX3's preamp or setting a lower preamp gain level in the KX3 menu. This is a per-band setting.

Dip in Spectral Response Close to VFO Frequency: I/Q demodulation at baseband (used by the PX3 and many SDR applications) may introduce small, very narrow-band amplitude variations in the response close to the carrier. This effect varies with operating mode and usually has no effect on operation. In CW mode the artifact can be moved by switching to CW reverse mode (ALT switch on KX3). Setting RX Shift to 8.0 rather than NOR in the KX3 menu may also vary to location of the artifact.

Some or All of the Spectrum Display is Magenta or Purple: This occurs when the filter bandwidth assigned to VFO B is nearly as wide as or even wider than the PX3 spectral display. The VFO B cursor/ bandwidth can be turned off using the VFO B menu entry.

Parameter Initialization

Menu parameters are stored in non-volatile EEPROM memory. It is possible, though rare, for parameters to become altered in such a way as to prevent the firmware from running correctly. If you suspect this, you can reinitialize parameters to defaults.

i Reinitializing the parameters will erase any Function key assignments you have made and return all of the MENU entries to the default values shown in page 30.

- Write down your function (FN) key assignments and menu parameters you have set.
- Turn the PX3 OFF (tap the PX3's **PWR** switch, not by turning off your power supply). Skip this step if the power-on jumper on the I/O board is in the "always-on" position.
- While holding in the **LABELS** key, hold the **PWR** switch for about 1/2second to turn the PX3 on. After about 2 seconds, let go of the **LABELS** key. You should now see **CONFIGURATION RESET** on the LCD screen.
- Re-enter all the menu parameters and function key assignments you wrote down.
- See if the original problem has been resolved.

PX3 Compared to the P3 and PC-Based Panadapters

The PX3 can display spans of up to 200 kHz, whereas most PC-based panadapters using I/Q demodulation are limited to about 40 kHz spans. The PX3 is also very tightly integrated with the KX3, making it very convenient to use.

Like PC-based panadapter applications, the PX3 makes use of baseband RX I/Q signals from the KX3. These signals are sampled by an analog-to-digital converter (ADC), and then mathematically processed to create the spectral and waterfall displays.

Because the process is analog, it is subject to possible noise pickup from various sources, including switching power supplies, 60-Hz AC, ground loops, and interface cables. That is why we recommend you use the cables supplied (see PX3CBL on page 5) and arrange the PX3 and KX3 as described under *Setup and Connections* on page 6.

In the case of a PC panadapter application, a sound card must be used and performance will only be as good as the ADC used on the sound card. The PX3's ADC is very high performance, resulting in a low noise floor, and the supplied cables are very short to minimize noise pickup. However, the PX3 is still subject to pickup from some noise sources, and the operator may see a few discrete spurs from station power supplies, etc., especially when wider spans are used (over 70 kHz or so). I/Q demodulation may also show a greater number of artifacts, such as opposite-sideband images, than I.F.-derived digital down-conversion (which is used in the P3). However, when the PX3 is properly aligned, such artifacts will be significantly suppressed (typically by 60 dB or better).

Theory of Operation

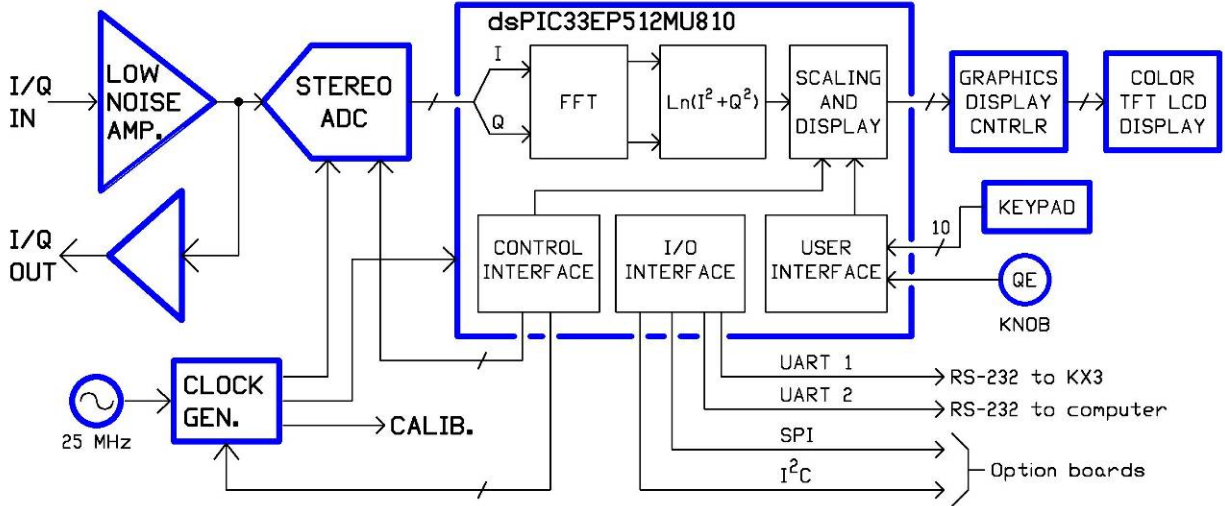

Figure 22. PX3 Simplified Block Diagram.

The input to the PX3 is a pair of signals from the KX3 transceiver that represent the in-phase (I) and quadrature (Q) components of the received RF signal. These signals are also buffered and sent back out so you can connect them to a personal computer or other device for additional processing. Both the I/Q input and output use differential amplifiers to isolate the grounds so that isolation transformers are not needed. The low-noise amplifier and high-dynamic-range analog to digital converter (ADC) ensure that weak signals can be received without overloading from strong signals. The ADC output is passed to a Microchip dsPIC digital signal processor/controller IC, which processes the digital I/Q signal from the ADC for presentation on the 480x272-pixel color TFT LCD display

The "circuitry" shown inside the processor box in the block diagram above is actually implemented as software routines. The FFT is the fast Fourier transform, which is a software version of a hardware spectrum analyzer. It reads the incoming signal and calculates the frequency spectrum. Further software routines calculate the power of the spectrum, take the logarithm, and then scale and offset the result so that it reads correctly in dBm on the display.

The dsPIC also acts as a controller for the rest of the circuitry. For example whenever the user changes the span, both the ADC decimation rate and the clock frequency are re-calculated. In that way, the optimum sample rate is used for any span, which optimizes the display update speed and ensures that each horizontal pixel on the display represents a distinct frequency, with minimum bleed-over between pixels.

One firmware task is to maintain communications with the KX3 transceiver over one of the RS232 ports. A special PX3-specific command set has been implemented to maximize communications efficiency. In addition, a special PX3-KX3 communications protocol was set up to ensure that the PX3 gets the information it needs when it needs it, so that the PX3 acts as a fully-integrated extension of the KX3. Communications between the computer and the KX3 is passed transparently through the PX3 so that the computer "thinks" it is talking directly to the KX3.

In addition to two UART (universal asynchronous receiver-transmitter) ports for the two RS232 connectors, SPI (serial peripheral interface) and I²C (inter-integrated circuit) interfaces are provided for future option modules. Those interfaces, plus power supplies and other signals, are passed via a 40-pin connector through the power supply board.

For best efficiency, the +3.3 V and +5 V internal power supplies are supplied by a pair of switching DC-DC converters from the +12 VDC input. The input power is approximately independent of the voltage, which means the lower the input voltage the higher the current.

RS-232 Serial Interface Cable

Your PX3 was furnished with a serial interface cable that uses an USB port on your computer. Optionally you can use a cable designed for an RS-232 port. You can order a cable from Elecraft. Order part number KXSER. You can also assemble your own if desired. Figure 23 is a schematic diagram of the cable.

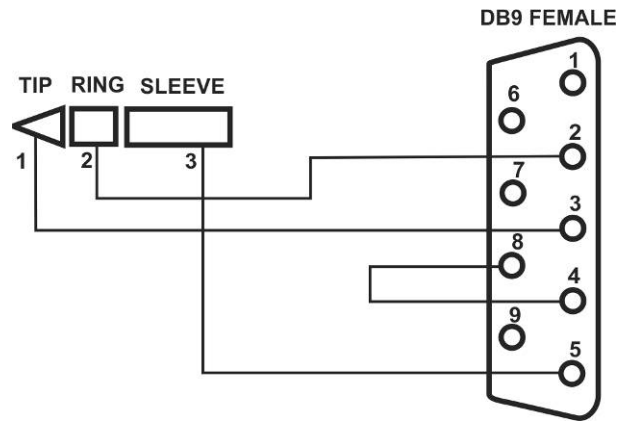

Figure 23. RS-232 Cable Schematic Diagram.

Kit Assembly Instructions

Preventing Electrostatic Discharge Damage

Sensitive components in your PX3 are may be damaged by Electrostatic Discharge (ESD) in any location or climate unless you take specific steps to prevent such damage. Many components can be damaged by static discharges of only a few volts: far too little for you to notice.

ESD damage may not be apparent at first. The damaged components may not fail completely. Instead, the damage may result in below-normal performance for an extended period of time before you experience a total failure.

We strongly recommend you take the following anti-static precautions (listed in order of importance) to ensure there is no voltage difference between the components and any object that touches them:

- Leave ESD-sensitive parts in their anti-static packaging until you install them. The packaging may be a special plastic bag that allow static charges to flow harmlessly over their surface, or the component's leads may be inserted in conductive foam that keep them at the same potential. Parts which are especially ESD-sensitive are identified in the parts list and in the assembly procedures.
- Wear a conductive wrist strap with a series 1-megohm resistor that will constantly drain off any static charge that accumulates on your body. If you do not have a wrist strap, touch a ground briefly before touching any sensitive parts to discharge your body. Do this frequently while you are working. You can collect a destructive static charge on your body just sitting at the work bench.

WARNING

DO NOT attach a ground directly to yourself without a current-limiting resistor as this poses a serious shock hazard. A wrist strap must include a 1-megohm resistor to limit the current flow. If you choose to touch an unpainted, metal ground to discharge yourself, do it only when you are not touching any live circuits with any part of your body.

- Use a grounded anti-static mat on your work bench.
- If you choose to use a soldering iron to work on your PX3 for any reason, be sure your iron has an ESD-safe grounded tip tied to the same common ground used by your mat or wrist strap.

Tools Required



1. #0 and #1 size Phillips screwdrivers. Use the screwdriver that best fits the screw in each step. To avoid damaging screws and nuts, a power screwdriver is *not* recommended.
2. Needle-nose pliers.
3. Knife with small sharp tip (e.g hobby knife)

The following tools are strongly recommended:

1. ESD wrist strap.
2. Static dissipating work pad.

Parts List

PX3 Front Panel Assembly Bag E850621

ILLUSTRATION	DESCRIPTION	QTY.	ELECRAFT PART NO.
	Front Panel	1	E100484SS
	Display Bezel	1	E100479

Individually Wrapped Components



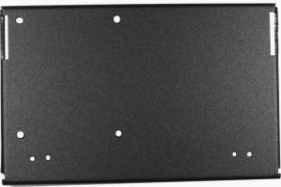
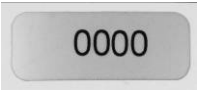







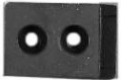









ILLUSTRATION	DESCRIPTION	QTY.	ELECRAFT PART NO.
	Right Side Panel	1	E850618
	Left Side Panel	1	E850617
	Rear Panel	1	E850619
	Serial Number Label	1	E850623
	PX3 Cable	1	PX3CBL
	Power Cable, 18AWG, Right Angle	1	E850524

ILLUSTRATION	DESCRIPTION	QTY.	ELECRAFT PART NO.
	Serial Data Cable	1	KXUSB
 <p data-bbox="170 636 646 737">⚠ Do not remove the rubber band or protective film on the LCD until instructed to do so.</p>	PX3 Front Panel Board with LCD and Switch Matrix. ⚠ Take ESD Precautions before handling this board.	1	E850624
	PX3 Power Supply Board ⚠ Take ESD Precautions before handling this board.	1	E850604

PX3 Misc Bag - E850615

ILLUSTRATION	DESCRIPTION	QTY.	ELECRAFT PART NO.
	Tilt Foot, Left	1	E980183
	Tilt Foot, Right	1	E980184
	Rubber Foot	4	E980185
	Knob	1	E980088
	PX3 Hardware Envelope (see below for contents)	1	E850614

PX3 Hardware Envelope – E850614

ILLUSTRATION	DESCRIPTION	QTY.	ELECRAFT PART NO.
	4-40 Thumb Screws	4	E700050
	Screw, Black, Pan Head, 2-56 1/4" (6.4 mm)	10	E700124
	Screw, Black Nylon, Pan Head 4-40 1/4" (6.4mm)	6	E700282
	Screw, Black, Flat Head, 4-40 1/4" (6.4 mm)	4	E700253
	Standoff, Threaded, 2-56 5/16" (7.9 mm)	4	E700297
	Standoff, Threaded, Nylon, 2-56 7/16" (11 mm)	1	E700306
	Lock Washer, Split Ring, #2	10	E700123
	Flat Washer, #4	2	E700044
	Hex Nut and Flat Washer (see note below)	1 set	E700301
	Knurled Nut (see note below)	2	E700300

Note: If these items are not in the bag, you should find them on the connectors on the PX3 Front Panel and PX3 Power Supply boards.

Assembly Procedure

Overview of the Kit

All of the circuits are contained on two pc boards, the front panel board and the power supply board. Figure 24 shows the inside of the assembled PX3 with the rear panel removed. The front panel board with the liquid crystal display (LCD) and switch matrix mounts in the top cover. The power supply board plugs into the front panel board.

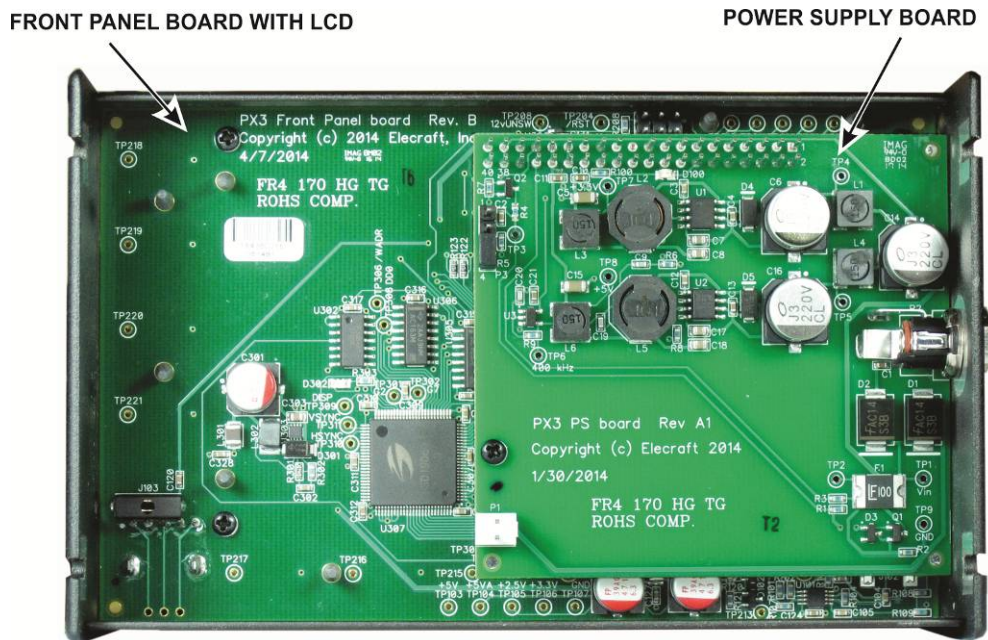

Figure 24 Assembled PX3 with Rear panel Removed.

⚠ CAUTION: The PC Boards are ESD-sensitive. Wear an ESD-safe wrist strap or touch a metallic ground regularly while handling the boards or at any time while working inside the PX3. See *Preventing Electrostatic Discharge Damage* on page 37 for more information.

Before starting construction, do a complete inventory, comparing the parts in your kit with the parts list beginning on 38, to familiarize yourself with all of the parts and to ensure the kit is complete, **but do not remove the rubber band around front panel display board until instructed to do so in the assembly procedure. It holds the LCD in place until the board is installed.** If any parts are missing, contact Elecraft for a replacement (see, *Customer Service and Support* on page 56). Recommend you also keep the printed circuit board assemblies in their anti-static packaging until you are instructed to remove them.

□ Remove the front panel display board from its anti-static packaging. Do not remove the rubber band, It is holding the LCD in place. Mount four 2-56 5/16" (7.9 mm) standoffs on the front panel display board as shown in Figure 25. Be sure to place one lock washer between the standoff and the pc board as shown. This lock washer is important to establish the proper height of the standoff.

ⓘ You may find it easiest to install both lock washers by holding the screw and first lock washer in place in each hole, then using your needle-nose pliers or tweezers to add the lock washer on the LCD side of the board, followed by the standoff.

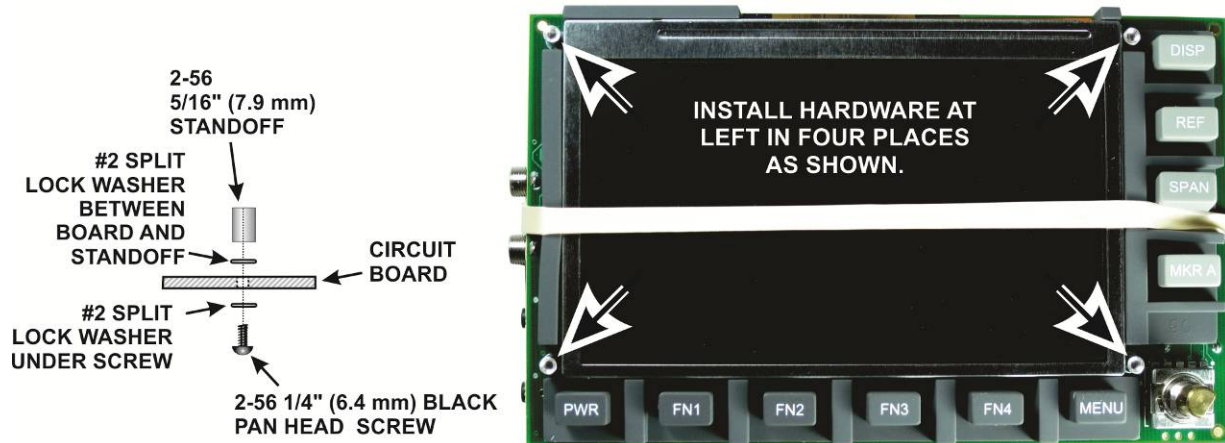

Figure 25. Mounting the Front Panel Standoffs.

□ Locate the front panel. On the inside are four small pieces of conductive tape covering screw holes at each corner of the large opening for the LCD (see Figure 27). **Do not remove this tape!** It provides an essential ground for the LCD when the front panel board is mounted. Use a sharp knife point or other tool to open the tape over each screw hole. Work from the inside so you do not push the tape away from the panel. This is needed to mount the front panel board later, but first you will need to prepare the front panel board for installation in the next few steps.

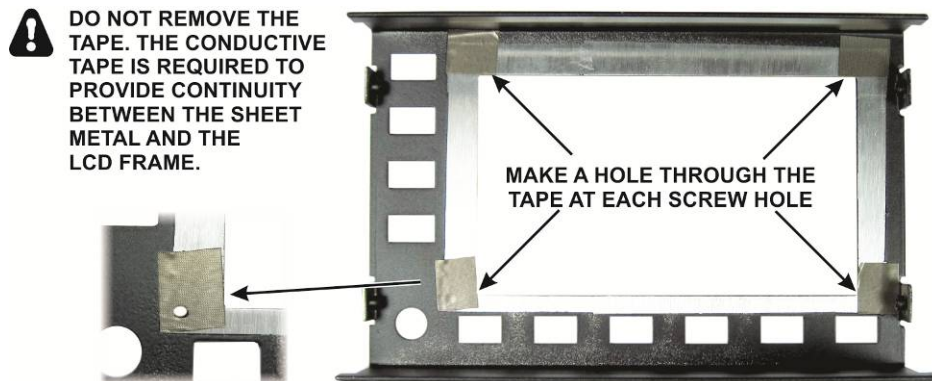

Figure 26. Front Panel Conductive Tape.

□ Place the front panel face up on your work table. Carefully remove the rubber band holding the LCD in place and prop the front panel board up on its **top** edge against your work table. Install the threaded nylon standoff on the board as shown in Figure 27. Tighten only until the standoff is snug. Do not over-tighten or you will strip the threads in the standoff. The installed standoff is shown Figure 28, If one of the ribbon cables does come loose, see *Replacing the LCD* on page 54.

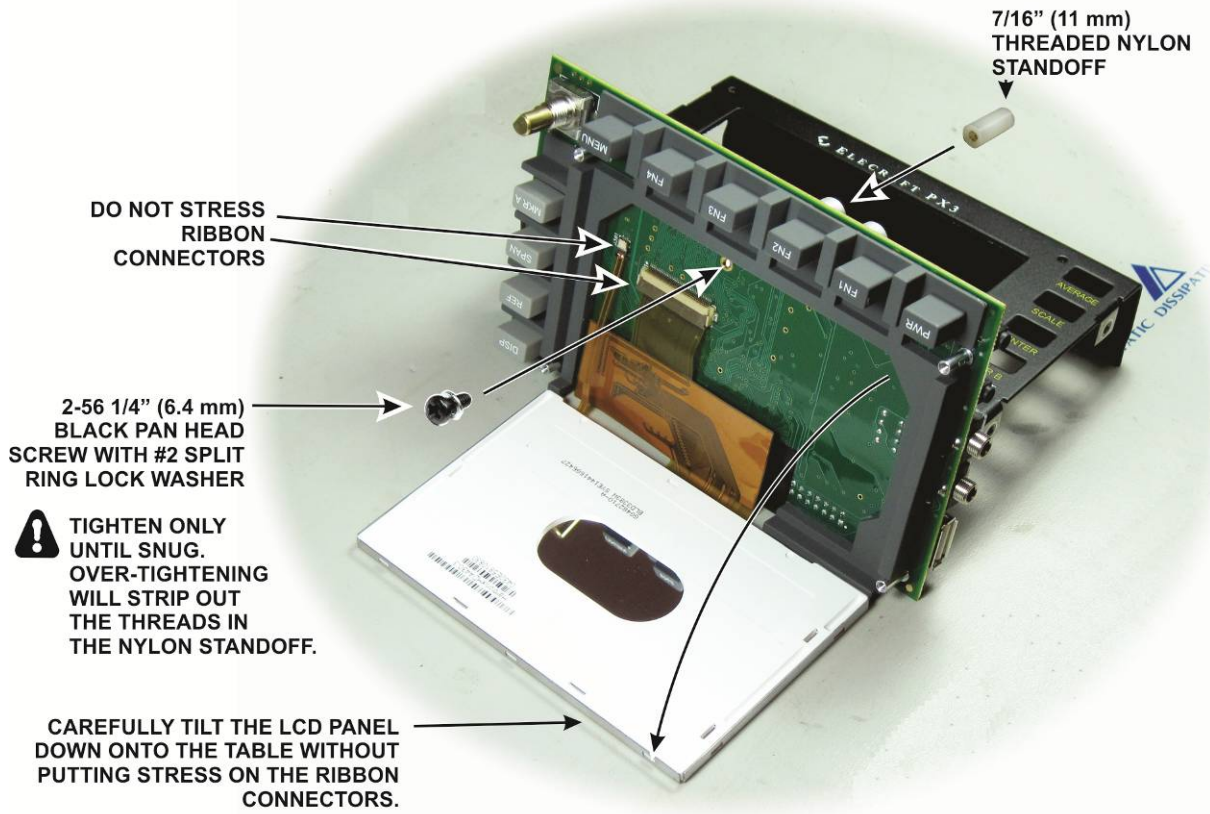

Figure 27. Installing the Nylon Standoff on the Front Panel PC Board.

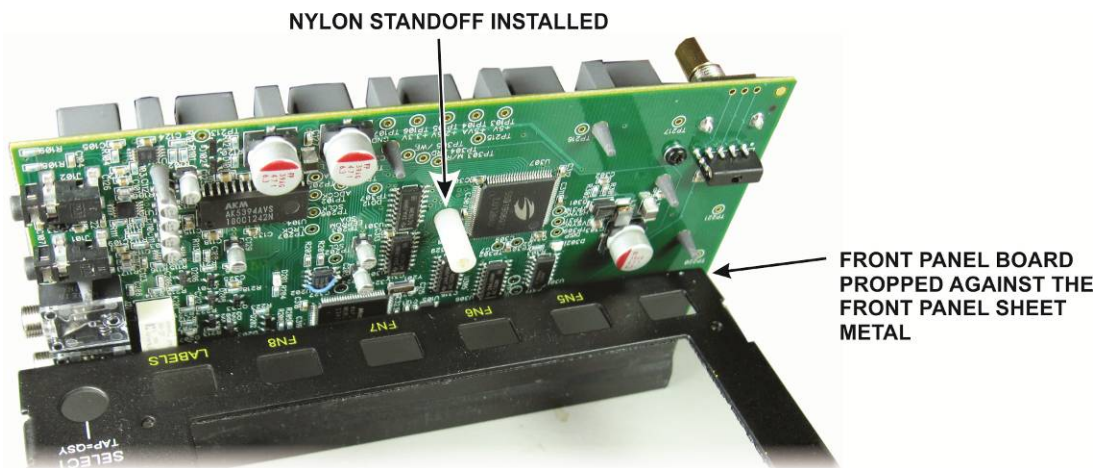

Figure 28. Nylon Standoff Installed.

□ Replace the LCD in the rubber matrix and lay the front panel board face up on your work table. Remove the thin plastic film over the LCD using a sharp edge to pick up one corner as shown in Figure 29 and then peel the plastic off of the LCD.

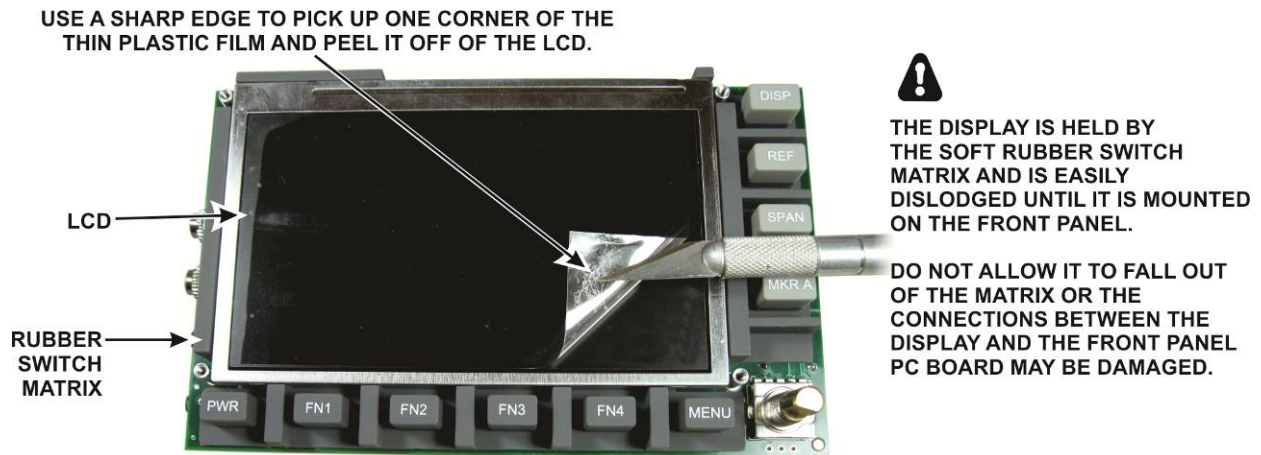

Figure 29. Removing the Plastic Film from the LCD.

□ Remove the plastic display bezel from its protective wrapping and inspect it for dirt and dust, especially on the flat side that will face the display panel. Use a soft cloth if necessary to remove any objects clinging to the plastic. Similarly, inspect and clean the face of the display. If either requires further cleaning see *Cleaning the LCD Bezel* on page 53.

□ Look closely at the edge of the bezel and note that the edge is slightly beveled on one side (see Figure 30). This side will face away from the front panel.

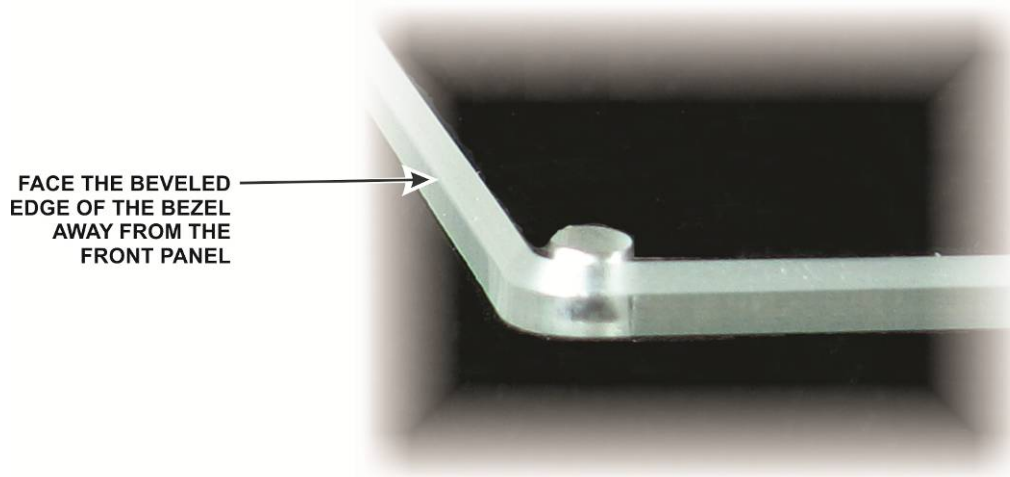

Figure 30. Bezel Beveled Edge.

□ Hold the front panel board face up so the LCD does not become dislodged and place the front panel sheet metal and bezel over it as shown in Figure 31. Insert the front panel board from the back of the sheet metal, angling it as needed to fit past the narrow part of the panel. Place the bezel on top of the front panel sheet metal and secure it as shown, threading the screws through the bezel, top cover and into the standoffs you installed earlier on the front panel board. Do not use lock washers. **Do not over-tighten the screws. You can distort or break the bezel.**

ⓘ It is generally easier to insert two of the screws through the bezel and sheet metal at opposite corners, and then position the front panel board, starting the two screws into the threaded standoffs on the front panel board. Finally, add the last two screws and tighten only until the screws are snug.

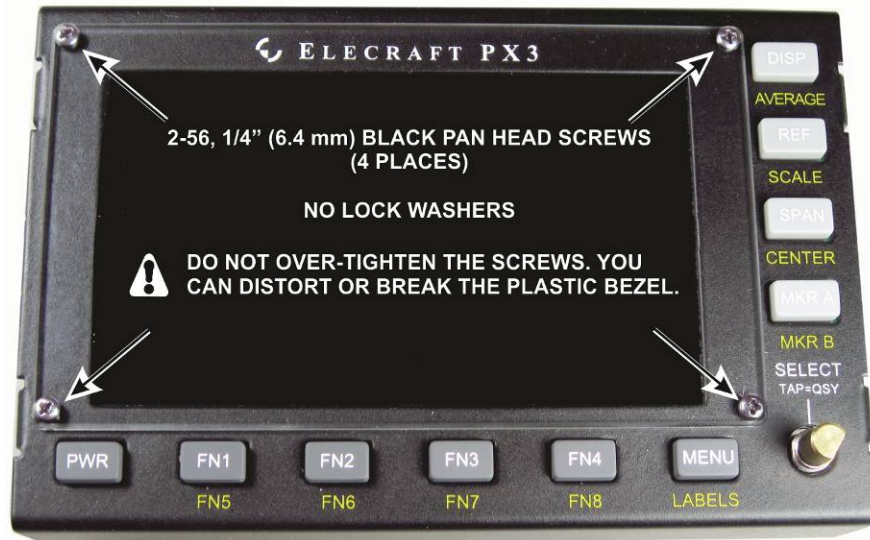

Figure 31. PC Board and Bezel Mounted on Front Panel.

□ Check to ensure the knob has its spring insert in place, then press it onto the shaft. Be sure the flat on the shaft is aligned with the flat surface in the knob (see Figure 32). The control has a built-in switch so do not be surprised to hear a click when you press the knob onto the shaft. The knob will stand above the surface of the front panel to allow room for the knob to move when operating the switch. Also, some side-to-side movement of the knob is normal in a control of this type with a built in switch.

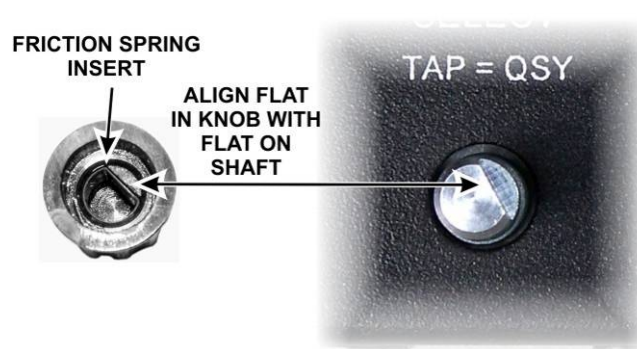

Figure 32. Installing the Knob.

□ Remove the power supply pc board from its packaging and mount it on the back of the front panel board as shown in Figure 33. Be sure the multi-pin connectors are properly lined up and fully mated as shown. The connectors fit very tightly.

i While pressing the boards together, rock the power supply board to “walk” the connectors together as shown.

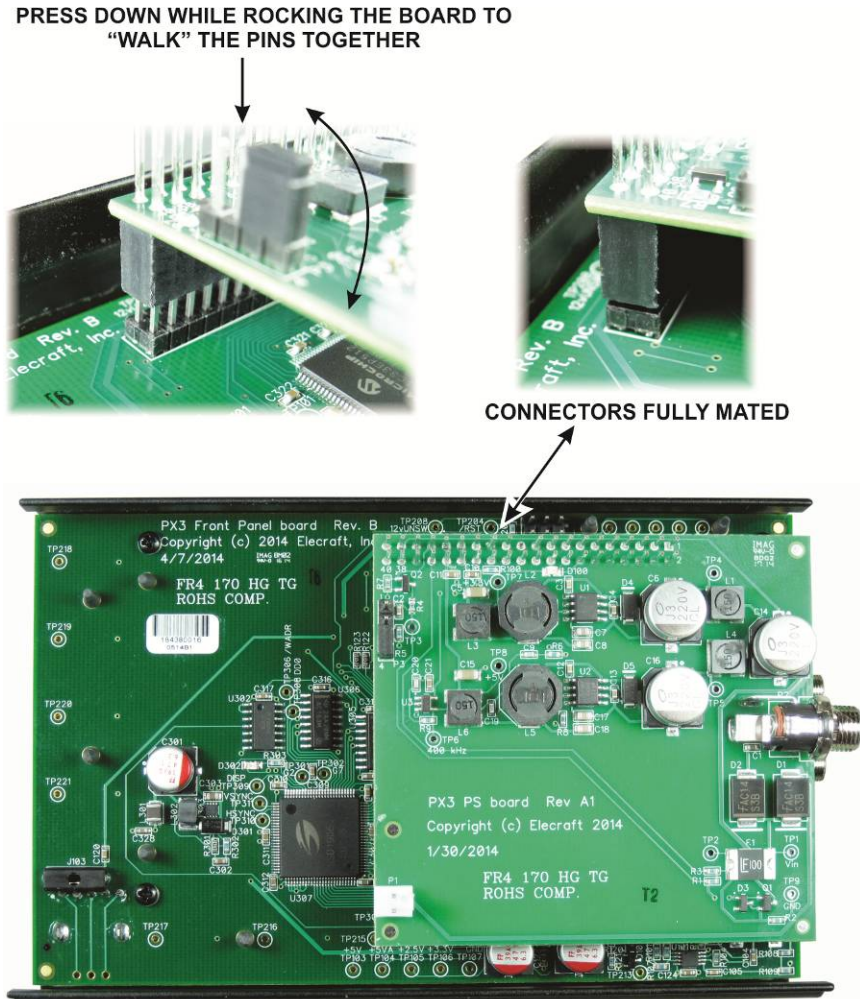

Figure 33. Mating the Power Supply Board Connectors.

- Attach the power supply board to the nylon standoff using a screw and lock washer as shown in Figure 34.

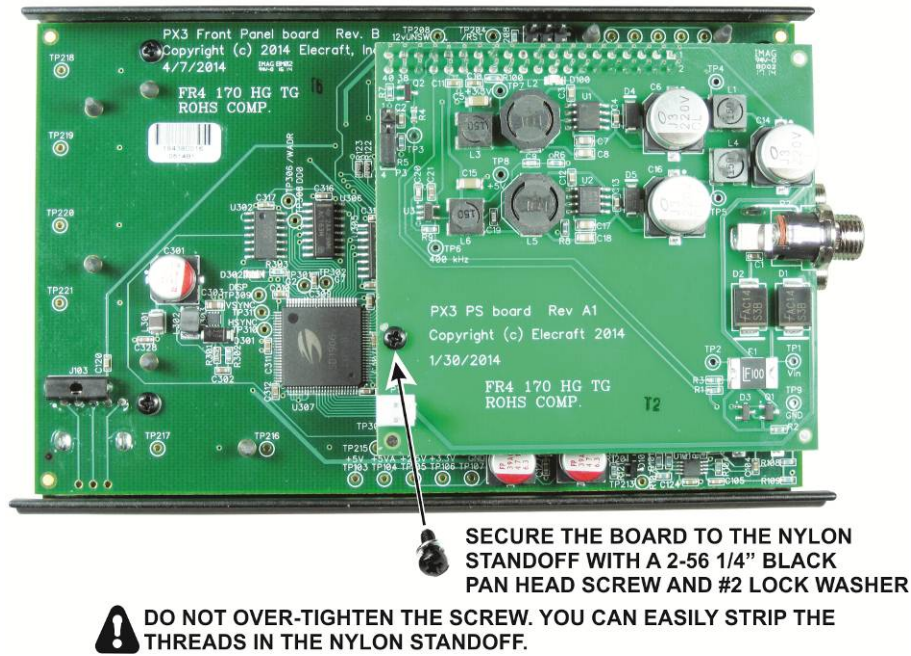

Figure 34. Installing the Power Supply Board Mounting Screw.

- Be sure the jumper is installed on the Power Supply Board as shown in Figure 18 on page 22. By positioning the jumper, you can choose how the PX3 power switch behaves as described in the accompanying text.
- Unwrap the left side panel and clean the inside surface as needed in the five locations shown in Figure 35
- i** If a hole is completely covered with tape, push a blunt tool through from the other side to break it loose.

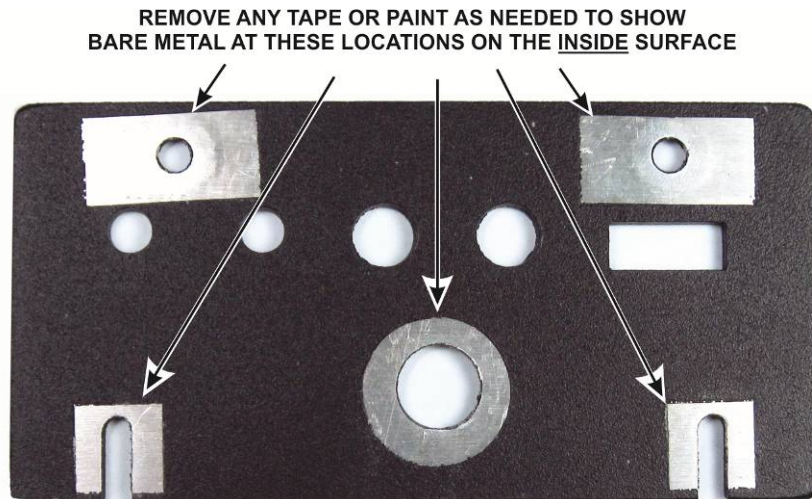

Figure 35. Preparing the Inside Surface of the Left Side Panel for Mounting.

□ Inspect the outside of the side panel to be sure there is a thin ring of bare metal around the ACC1 PC and ACC1 XVCR connector openings as shown in Figure 36. When the side panel is mounted, nuts on the connectors will press against the bare metal to properly ground the connector. Normally the panels are cleaned at the factory to avoid accidental scratches on the exterior surface but, if needed, very carefully clean the metal off so it is as shown in the image. Keep the bare metal surface a thin ring so the nut on the connector will completely hide it.



Figure 36. Checking the Grounding Surface on the ACC1 PC and XVCR Connector Openings.

□ Position the left side panel on the front panel assembly and install the two knurled nuts as shown in Figure 39. The knurled nuts must be installed first to ensure the nuts fit properly into recessed openings and contact the bare metal. Note that the knurled nuts have slots on the side facing away from the panel. You can tighten the nuts with a small screwdriver or other tool pressed gently in the slot. Take care to avoid scratching the paint.

⚠ If the connectors do not like up with the holes as shown, be sure you mounted the plastic bezel on the outside of the front panel as shown in Figure 31 on page 45.

⚠ THE TWO NUTS SHOWN MUST BE INSTALLED FIRST TO ENDURE THEY PROPERLY MATE WITH THE BARE METAL SURFACE UNDERNEATH.

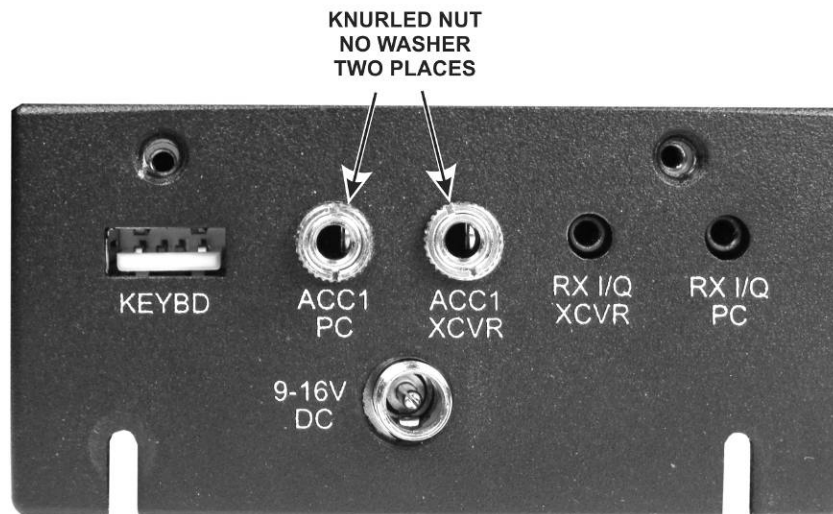

Figure 37. Mounting the Left Side Panel Part 1.

- Add the hex nut and washer on the power connector and the two flat head screws as shown in Figure 38 to complete mounting the left side panel.

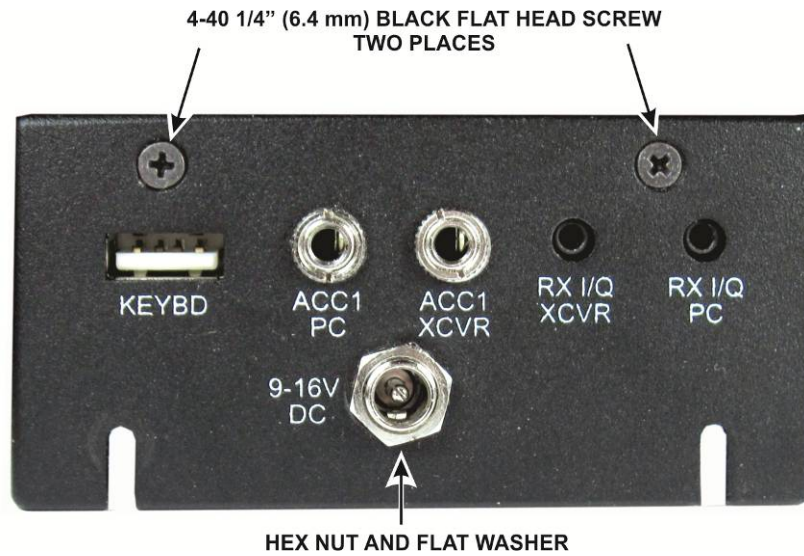

Figure 38. Mounting the Left Side Panel Part 2.

- Unwrap the right side panel and clean it as needed (see Figure 39). The paint is **not** removed from any areas on the outside of this panel.

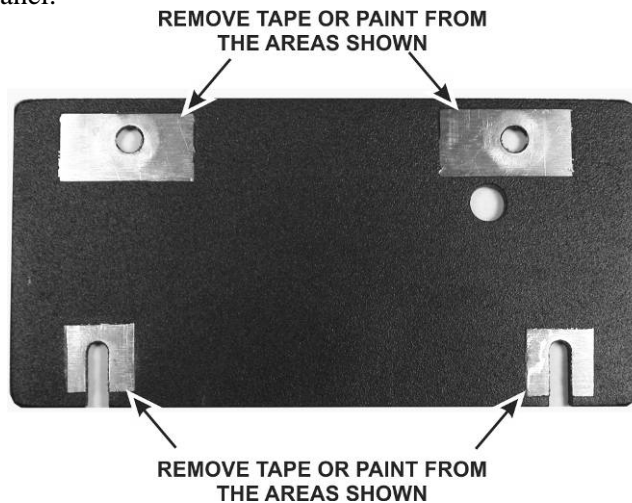

Figure 39. Preparing the Right Side Panel for Mounting.

- Mount the right side on the front panel assembly using two 4-40 1/4" (6.4mm) flat head screws just as you did the left side panel, but no connectors are mounted on this end. The one hole allows access to a connector inside the PX3.

- Locate the two tilt legs and four rubber feet. Mount one rubber foot on each tilt leg as shown in Figure 40. The feet are held in place by friction. Be sure the feet are worked all the way onto each foot as shown.

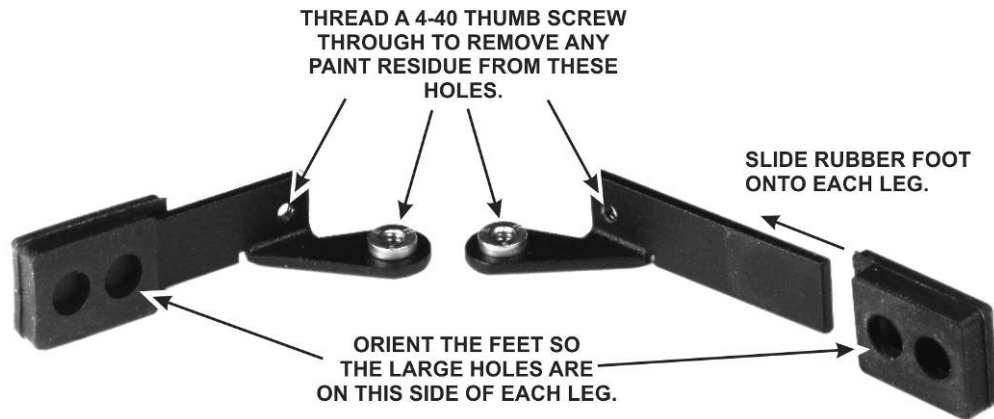

Figure 40. Preparing the Tilt Legs for Installation.

- Install a flat washer and black nylon screw on each tilt leg as shown in Figure 41. Note the orientation of the screw as well as the rubber foot that you installed earlier. They must be as shown for the foot to work properly.

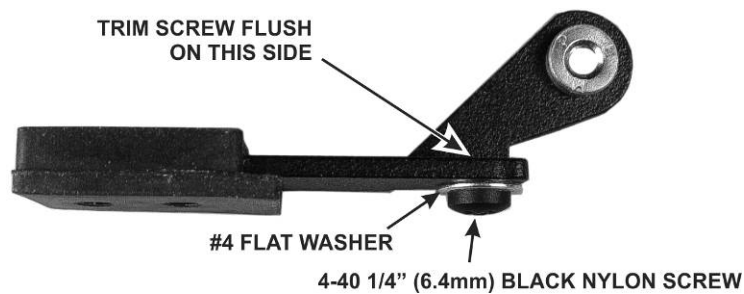

Figure 41. Placing Nylon Bumpers on the Tilt Legs.

- Unwrap the bottom panel and clean away tape or paint from each end as shown in Figure 42.

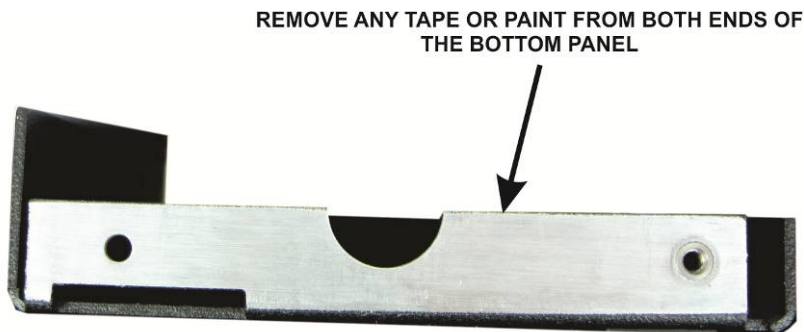

Figure 42. Rear Panel Ends Cleaned.

Install the remaining two feet on the rear panel as shown in Figure 43. If the threaded holes have paint in them, clear the paint by running one of the 4-40 thumb screws through the holes first. Note that the remaining four holes are for future use. Peel the serial number off of the backing paper and affix it as shown. Some builders prefer to attach the serial number as the very last step of assembly. There is no reason it must be attached now, but many builders find it easier to get the label on straight when the cover can be laid flat and stable on the work table.

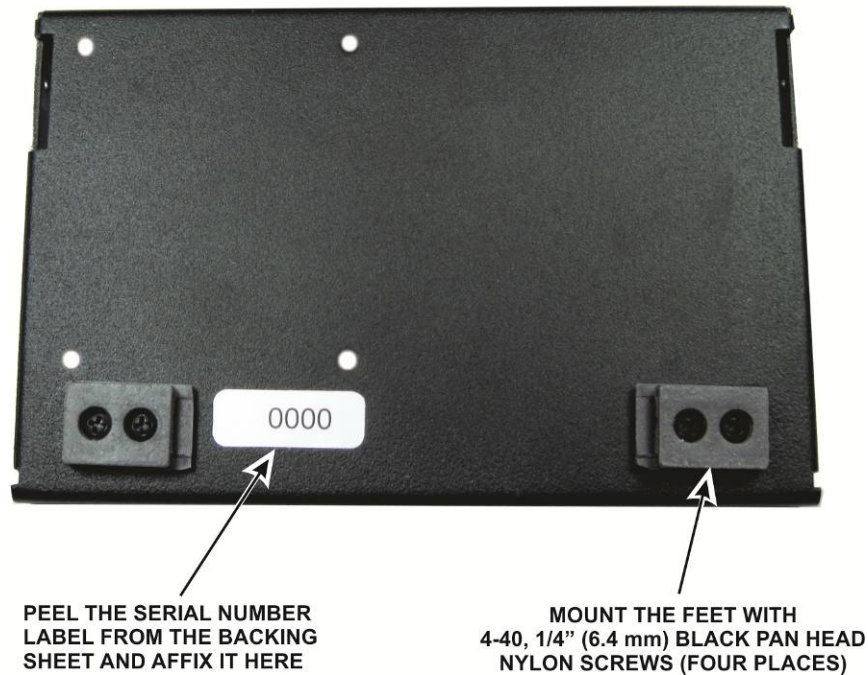

Figure 43. Installing Fixed Feet and Serial Number on the Rear panel.

Install the two tilt feet in the slots in the rear panel as shown in Figure 44. Do not tighten the thumb screws. Leave them loose until the front panel assembly is mounted.

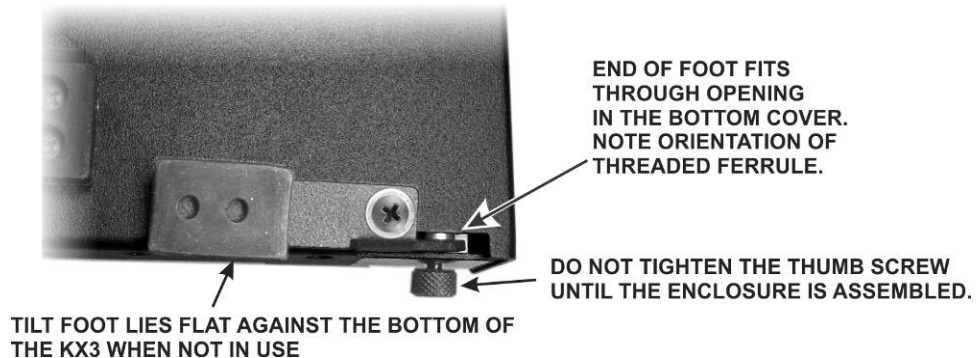

Figure 44. Installing the Tilt Feet in the Rear Cover.

Assemble the front panel assembly and rear cover as shown in Figure 45 and tighten the thumb screws only until snug. To use the tilt feet, loosen the two rear thumb screws and swing the feet down, then retighten the thumb screws.

⚠ Always loosen the rear thumb screws completely before adjusting the tilt feet. Failing to do may cause a thumbscrew to tighten as you move the foot, making it very hard to loosen later.

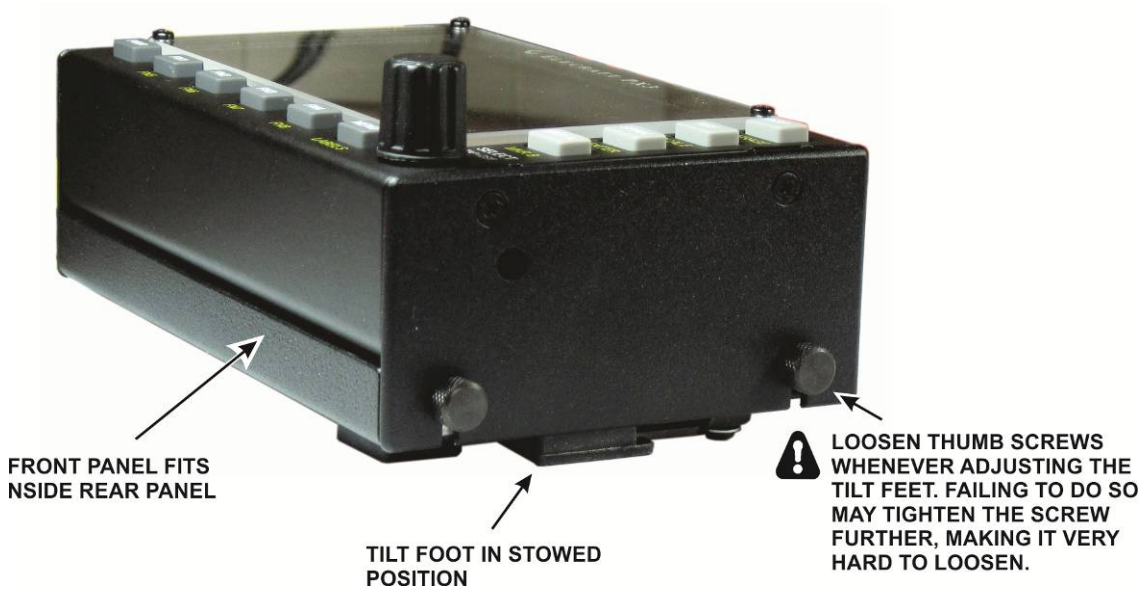

Figure 45. Assembling the Enclosure.

That completes the assembly of your PX3 Panadapter kit.

Servicing the PX3

⚠ CAUTION: The PC Boards inside the PX3 are ESD-sensitive. Wear an ESD-safe wrist strap or touch a metallic ground regularly at any time while working inside the PX3. See *Preventing Electrostatic Discharge Damage* on page 37 for more information.

Accessing the PC Boards

Loosen the four knurled nuts and separate the case halves to access the pc boards. Two pc boards carry all of the circuitry: the front panel board on which the LCD is mounted and the power supply board that plugs into the back of the front panel board.

To remove the boards, first remove the nuts on the connectors on the left side panel, and then the two screws holding the side panel on the front panel assembly (See Figure 37 on page 48 and Figure 38 on page 49).

⚠ When replacing the left side panel, be sure to first tighten the knurled nuts on the ACC1 XCVR and ACC1 PC connectors as shown in the figures to ensure the connectors are grounded properly against the bare metal ring around the opening.

Remove the screw holding the power supply board to the front panel board (see Figure 34 on page 47) and then separate the connectors. Rock the power supply board while lifting it off as shown in Figure 33 on page 46 .

To remove the front panel board and gain access to the LCD, remove the knob (see Figure 32 on page 45) and the four screws on the plastic bezel (Figure 31). That will free both the front panel board assembly and the plastic bezel. Take care not to scratch the bezel or lose the screws. You will need to tilt the front panel board assembly to remove it from the front panel sheet metal.

Cleaning the LCD Bezel

When the power is off and the LCD is dark, fingerprints and dust become clearly visible on the bezel covering the LCD screen. Avoid rubbing the bezel. It is easily scratched. Use a very soft cloth and gentle pressure. If the bezel requires more extensive cleaning or cleaning on the inside surface, remove the front panel assembly, lay it face up and then remove the four screws holding the bezel. Note that this will also release the front panel circuit board with the LCD. Mild liquid dish soap is a good cleaner and has the effect of dissipating dust-attracting static charges. Blot the bezel dry rather than wiping it.

If the LCD itself is dirty, use a soft cloth to wipe it clean. If necessary, dampen the cloth slightly with a mild cleaner (lens cleaner for eye glasses is good). The front surface of the LCD is a plastic polarizing filter that is essential for its operation. This filter is easily scratched.

Replacing the LCD

Remove the front panel board with the LCD display from the PX3 front panel. Place the board on your work table with the top of the board nearest you. Arrange a book or other object about level with the key matrix against the bottom of the front panel board to support the LCD when you free it from the key matrix (see Figure 46).



Figure 46. Removing LCD Panel from Rubber Key Matrix.

Gently pry up the top edge of the LCD panel to free it from the switch matrix and fold it over onto the support as shown. Don't strain the two delicate ribbon cables or their connectors.

Use a fingernail to open the connectors and free the cables (see Figure 47). Be especially careful with the smaller connector. Note it opens from the end farthest from the cable. The white latch opens only slightly.

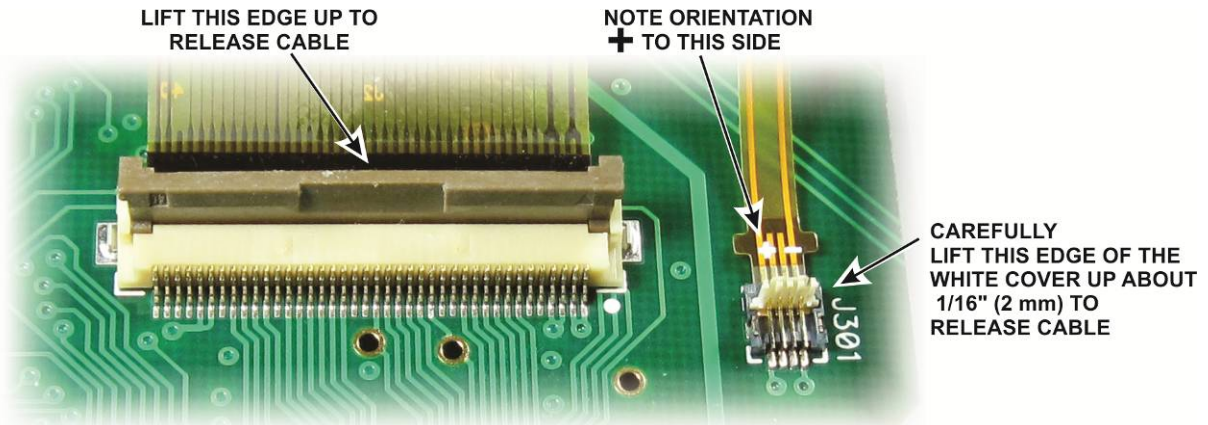

Figure 47. LCD Cable Connectors Opened.

When replacing the cables, be sure the smaller backlight cable is oriented with the + as shown.

Gently replace the LCD in the switch matrix. Be sure it is fully seated so the edge of the LCD panel is flush with the rubber matrix.

Specifications

Absolute Level Accuracy:	± 3 dB plus display resolution with KX3 preamp on.
Relative Level Accuracy:	± 0.1 dB plus display resolution
Display Update Rate:	Selectable 1 Hz to 20 Hz (slower at narrowest spans)
Amplitude Scale:	10 dB minimum, 80 dB maximum
Span:	2 kHz minimum, 200 kHz maximum
Resolution Bandwidth:	Span / 450, 8 Hz minimum
Power Requirements:	9 to 16 VDC. Approximately 195 mA at 13.8 VDC (max. screen brightness)
Weight:	12.7 oz (360 grams)
Size:	See Figure 48 below.

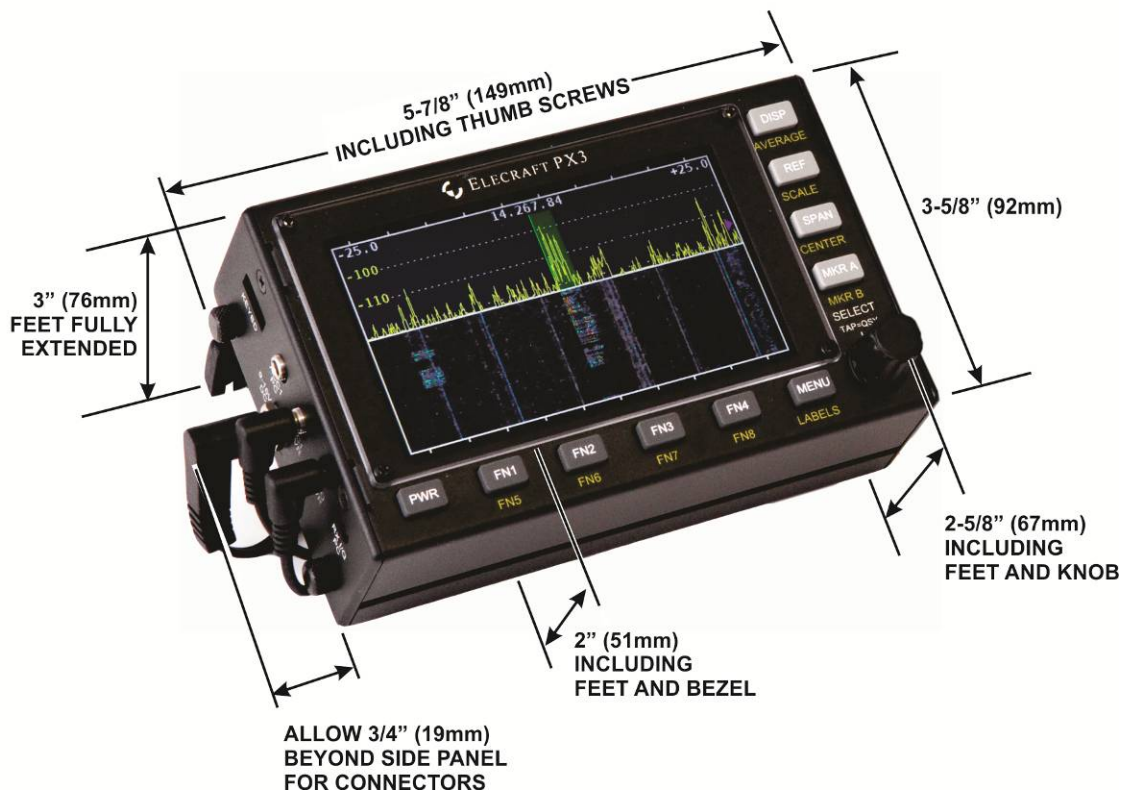

Figure 48. PX3 Dimensions.

Customer Service and Support

Technical Assistance

You can send e-mail to k3support@elecraft.com and we will respond quickly – typically the same day Monday through Friday. If you need replacement parts, send an e-mail to parts@elecraft.com. Telephone assistance is available from 9 A.M. to 5 P.M. Pacific time (weekdays only) at 831-763-4211. Please use e-mail rather than calling when possible since this gives us a written record of the details of your problem and allows us to handle a larger number of requests each day.

Repair / Alignment Service

If necessary, you may return your Elecraft product to us for repair or alignment. (Note: We offer unlimited email and phone support, so please try that route first as we can usually help you find the problem quickly.)

IMPORTANT: You must contact Elecraft before mailing your product to obtain authorization for the return, what address to ship it to and current information on repair fees and turnaround times. (Frequently we can determine the cause of your problem and save you the trouble of shipping it back to us.) Our repair location is different from our factory location in Aptos. We will give you the address to ship your kit to at the time of repair authorization. *Packages shipped to Aptos without authorization will incur an additional shipping charge for reshipment from Aptos to our repair depot.*

Elecraft 1-Year Limited Warranty

This warranty is effective as of the date of first consumer purchase (or if shipped from the factory, the date the product is shipped to the customer). It covers both our kits and fully assembled products. For kits, before requesting warranty service, you should fully complete the assembly, carefully following all instructions in the manual.

Who is covered: This warranty covers the original owner of the Elecraft product as disclosed to Elecraft at the time of order. Elecraft products transferred by the purchaser to a third party, either by sale, gift, or other method, who is not disclosed to Elecraft at the time of original order, are not covered by this warranty. If the Elecraft product is being bought indirectly for a third party, the third party's name and address must be provided at time of order to ensure warranty coverage.

What is covered: During the first year after date of purchase, Elecraft will replace defective or missing parts free of charge (post-paid). We will also correct any malfunction to kits or assembled units caused by defective parts and materials. Purchaser pays inbound shipping to us for warranty repair; we pay shipping to return the repaired equipment to you by UPS ground service or equivalent to the continental USA and Canada. For Alaska, Hawaii, and other destinations outside the U.S. and Canada, actual return shipping cost is paid by the owner.

What is not covered: This warranty does not cover correction of kit assembly errors. It also does not cover misalignment; repair of damage caused by misuse, negligence, or builder modifications; or any performance malfunctions involving non-Elecraft accessory equipment. The use of acid-core solder, water-soluble flux solder, or any corrosive or conductive flux or solvent will void this warranty in its entirety. Also not covered is reimbursement for loss of use, inconvenience, customer assembly or alignment time, or cost of unauthorized service.

Limitation of incidental or consequential damages: This warranty does not extend to non-Elecraft equipment or components used in conjunction with our products. Any such repair or replacement is the responsibility of the customer. Elecraft will not be liable for any special, indirect, incidental or consequential damages, including but not limited to any loss of business or profits.